

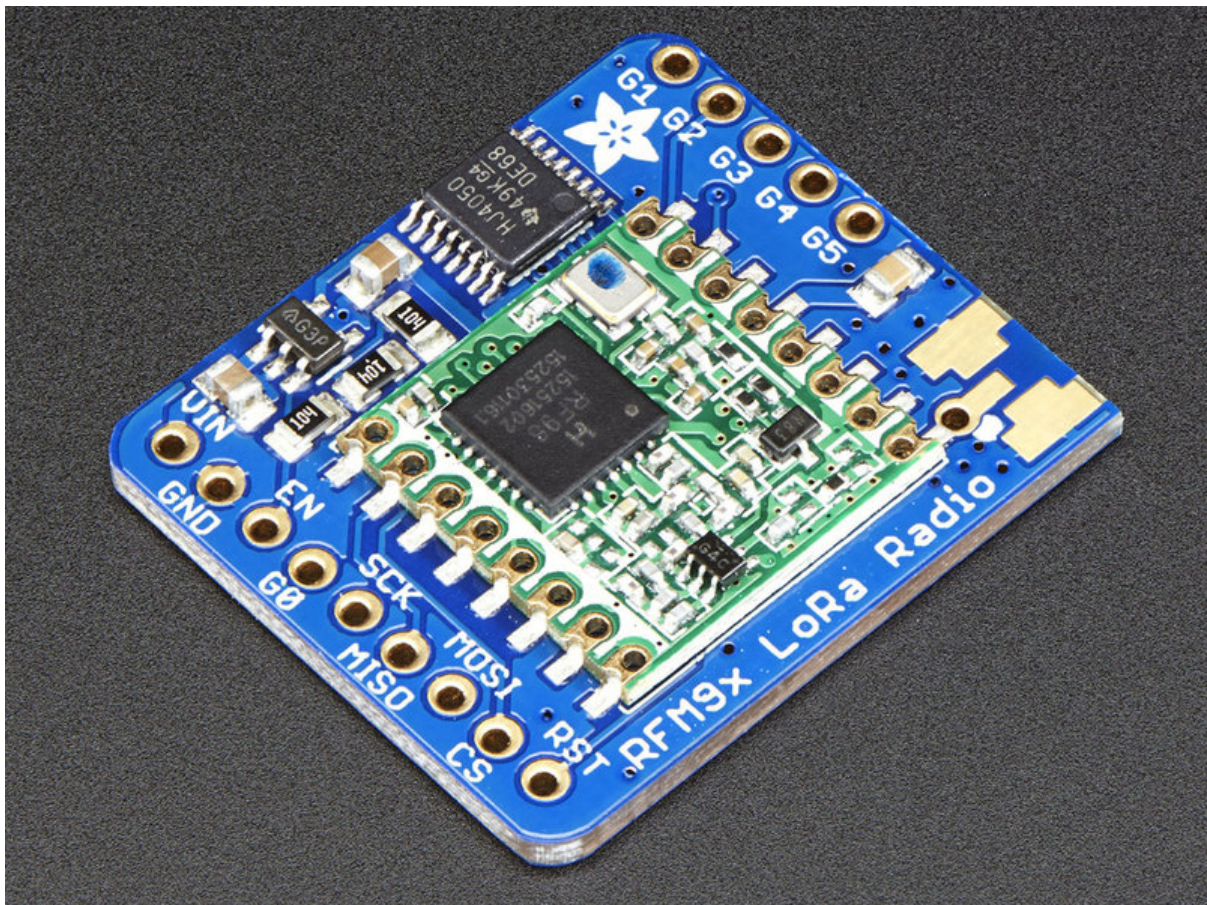

Adafruit RFM69HCW and RFM9X LoRa Packet Radio Breakouts

Created by lady ada



<https://learn.adafruit.com/adafruit-rfm69hcw-and-rfm96-rfm95-rfm98-lora-packet-radio-breakouts>

Last updated on 2024-07-12 01:03:09 PM EDT

Table of Contents

Overview	5
Pinouts	9
<ul style="list-style-type: none">• Power Pins• SPI Logic pins:• Radio GPIO• Antenna Connection	
Assembly	12
<ul style="list-style-type: none">• Prepare the header strip:• Add the breakout board:• And Solder!• Antenna Options• Wire Antenna• uFL Connector• SMA Edge-Mount Connector	
Arduino Wiring	22
Using the RFM69 Radio	24
<ul style="list-style-type: none">• "Raw" vs Packetized• Arduino Libraries• RadioHead Library example• Basic RX & TX example• Basic Transmitter example code• Basic receiver example code• Radio Freq. Config• Configuring Radio Pinout• Setup• Initializing Radio• Basic Transmission Code• Basic Receiver Code• Basic Receiver/Transmitter Demo w/OLED• Addressed RX and TX Demo	
CircuitPython for RFM69	37
<ul style="list-style-type: none">• Design Considerations• Wiring With Breakout• Usage with All-In-One Feather M0• Module Install• Usage• Beyond RX & TX	
Advanced CircuitPython RFM69 Library Usage	47
<ul style="list-style-type: none">• RadioHead Header• Node Addressing• Reliable Datagram	
Python Docs for RFM69	53

CircuitPython for RFM9x LoRa	53
<ul style="list-style-type: none">• Design Considerations• Wiring With Breakout• Usage with All-In-One Feather M0• Module Install• Usage• Beyond RX & TX	
Advanced CircuitPython RFM9x Library Usage	62
<ul style="list-style-type: none">• RadioHead Header• Node Addressing• Reliable Datagram• CRC Checking	
Python Docs for RFM9x LoRa	69
Advanced CircuitPython Library RFM9x/RFM69 - Tweaking Parameters	69
RFM9X Test	70
<ul style="list-style-type: none">• Arduino Library• RadioHead RFM9x Library example• Basic RX & TX example• Transmitter example code• Receiver example code• Radio Pinout• Frequency• Setup• Initializing Radio• Transmission Code• Receiver Code	
Downloads	80
<ul style="list-style-type: none">• Datasheets & Files• Schematic• Fabrication Print	
Radio Module F.A.Q.	82

Overview

"You see, wire telegraph is a kind of a very, very long cat. You pull his tail in New York and his head is meowing in Los Angeles. Do you understand this? And radio operates exactly the same way: you send signals here, they receive them there. The only difference is that there is no cat."

Sending data over long distances is like magic, and now you can be a magician with this range of powerful and easy-to-use radio modules. Sure, sometimes you want to talk to a computer (a good time to use WiFi) or perhaps communicate with a Phone (choose Bluetooth Low Energy!) but what if you want to send data very far? Most WiFi, Bluetooth, Zigbee and other wireless chipsets use 2.4GHz, which is great for high speed transfers. If you aren't so concerned about streaming a video, you can use a lower [license-free ISM frequency bands \(https://adafru.it/mOE\)](https://adafru.it/mOE) such as 433MHz in ITU Europe or 900 MHz in ITU Americas. You can't send data as fast but you can send data a lot farther.

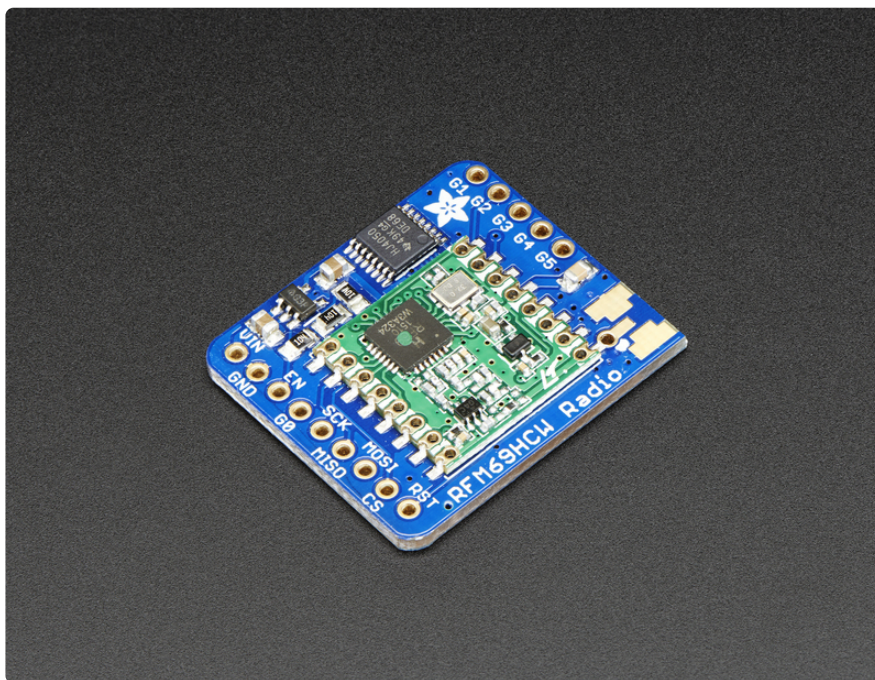

Also, these packet radios are simpler than WiFi or BLE, you don't have to associate, pair, scan, or worry about connections. All you do is send data whenever you like, and any other modules tuned to that same frequency (and, with the same encryption key) will receive. The receiver can then send a reply back. The modules do packetization, error correction and can also auto-retransmit so its not like you have to worry about everything but less power is wasted on maintaining a link or pairing.

These modules are great for use with Arduinos or other microcontrollers, say if you want a sensor node network or transmit data over a campus or town. The trade-off is

you need two or more radios, with matching frequencies. WiFi and BT, on the other hand, are commonly included in computers and phones.

These radio modules come in **four variants** (two modulation types and two frequencies) The RFM69's are easiest to work with, and are well known and understood. The LoRa radios are exciting and more powerful but also more expensive.

All variants are:

- Packet radio with ready-to-go Arduino libraries
- Uses the amateur or [license-free ISM bands \(https://adafru.it/mOE\)](https://adafru.it/mOE): 433MHz is ITU "Europe" license-free ISM or ITU "American" amateur with limitations. 900MHz is license free ISM for ITU "Americas"
- Use a simple wire antenna or spot for uFL or SMA radio connector

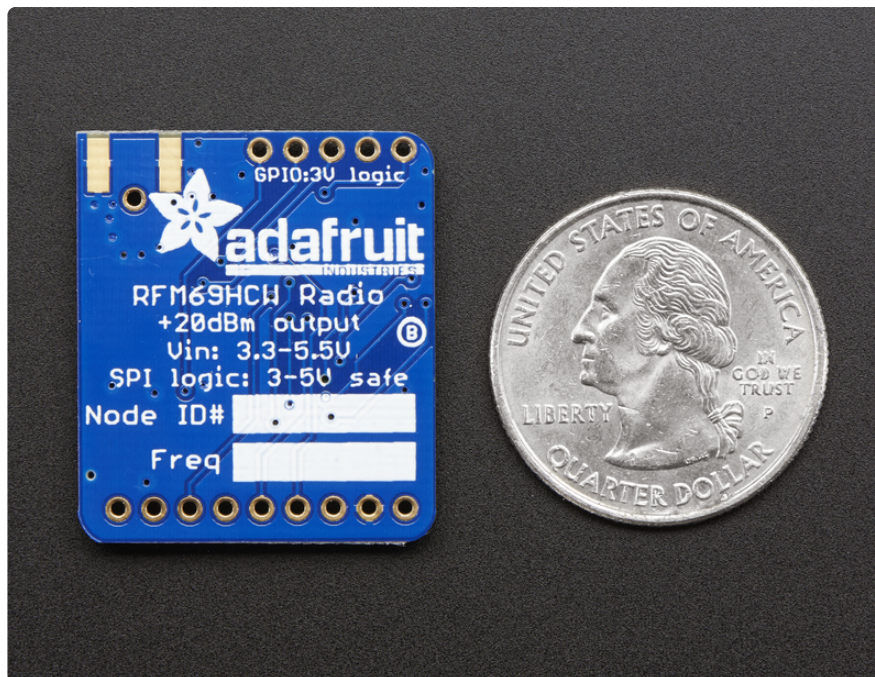

RFM69HCW in either 433 MHz or 868/915MHz

These are +20dBm FSK packet radios that have a lot of nice extras in them such as encryption and auto-retransmit. They can go about 200-500 meters line-of-sight using simple wire antennas, probably up to 5Km with well-tuned directional antennas, perfect line-of-sight, and settings tweakings

- SX1231 based module with SPI interface
- +13 to +20 dBm up to 100 mW Power Output Capability (power output selectable in software)

- 50mA (+13 dBm) to 150mA (+20dBm) current draw for transmissions, ~30mA during active radio listening.
- The RFM69 radios have a range of approx. 500 meters **line of sight** with tuned uni-directional antennas. Depending on obstructions, frequency, antenna and power output, you will get lower ranges - especially if you are not line of sight.
- Create multipoint networks with individual node addresses
- Encrypted packet engine with AES-128

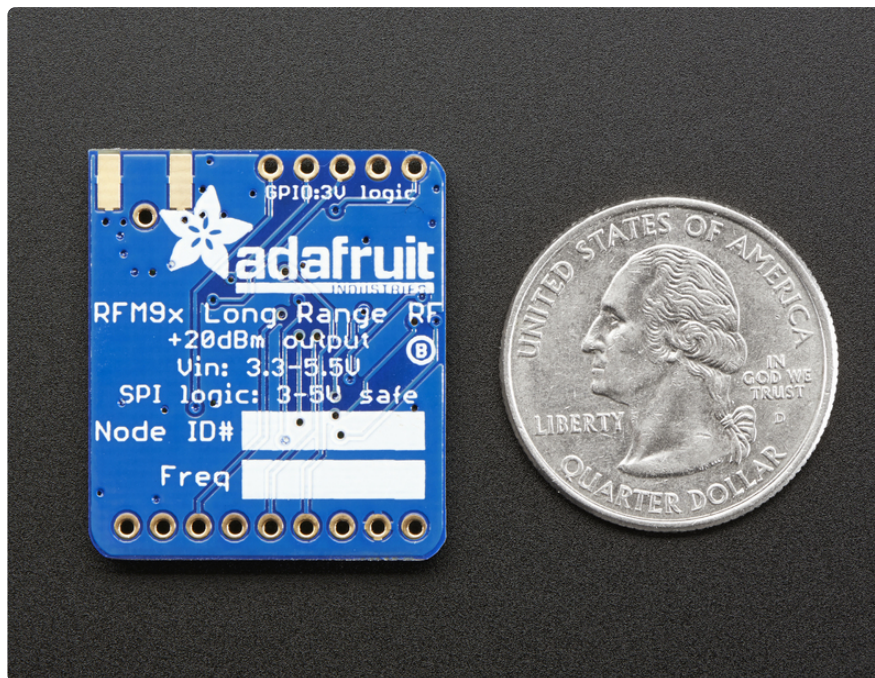

RFM9x LoRa in either 433 MHz or 868/915MHz

These are +20dBm LoRa packet radios that have a special radio modulation that is not compatible with the RFM69s but can go much much farther. They can easily go 2 Km line of sight using simple wire antennas, or up to 20Km with directional antennas and settings tweakings

- SX1276 LoRa® based module with SPI interface
- +5 to +20 dBm up to 100 mW Power Output Capability (power output selectable in software)
- ~100mA peak during +20dBm transmit, ~30mA during active radio listening.
- The RFM9x radios have a range of approx. 2 km **line of sight** with tuned uni-directional antennas. Depending on obstructions, frequency, antenna and power output, you will get lower ranges - especially if you are not line of sight.

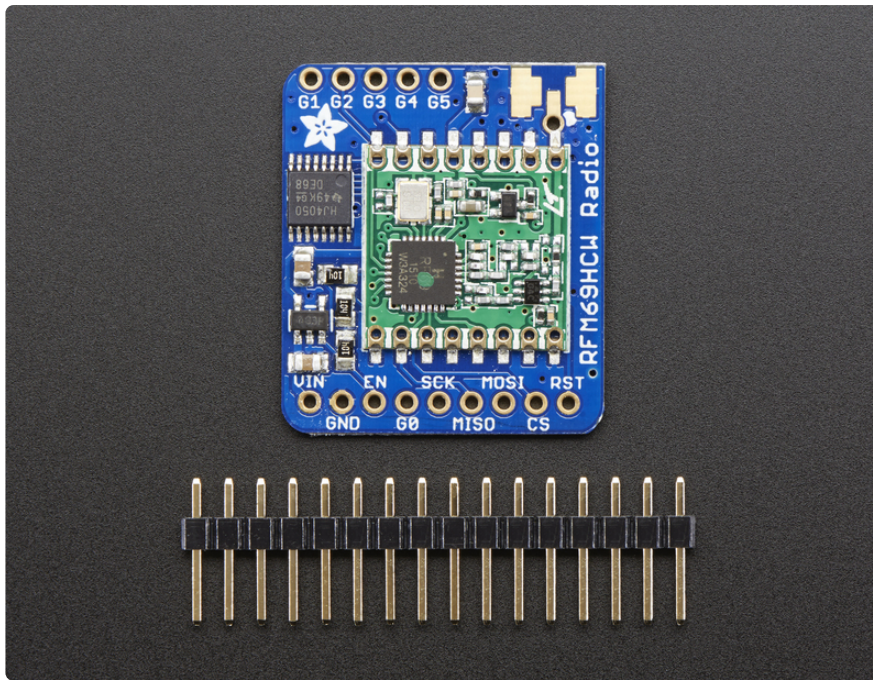

All radios are sold individually and can only talk to radios of the same part number. E.g. RFM69 900 MHz can only talk to RFM69 900 MHz, LoRa 433 MHz can only talk to LoRa 433, etc.

Each radio comes with some header, a 3.3V voltage regulator and levelshifter that can handle 3-5V DC power and logic so you can use it with 3V or 5V devices. Some soldering is required to attach the header. You will need to cut and solder on a small piece of wire (any solid or stranded core is fine) in order to create your antenna. Optionally you can pick up a uFL or SMA edge-mount connector and attach an external duck.

Pinouts

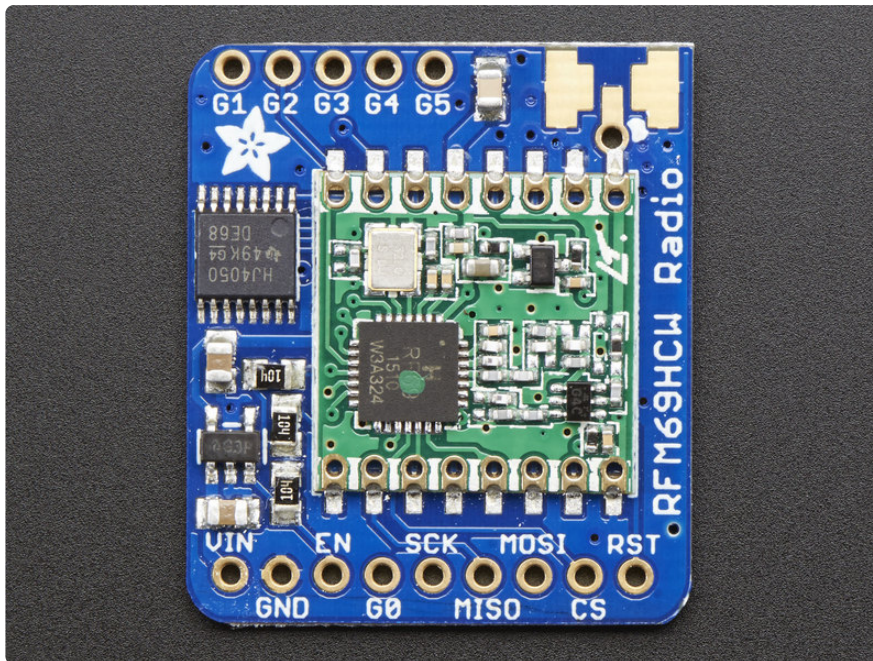

Both RFM69 and RFM9x LoRa breakouts have the exact same pinouts. The silkscreen will say RFM69HCW or LoRa depending on which variant you have. If there's a green or blue dot on top of the module, its 900 MHz. If there's a red dot, its 433 MHz

Power Pins

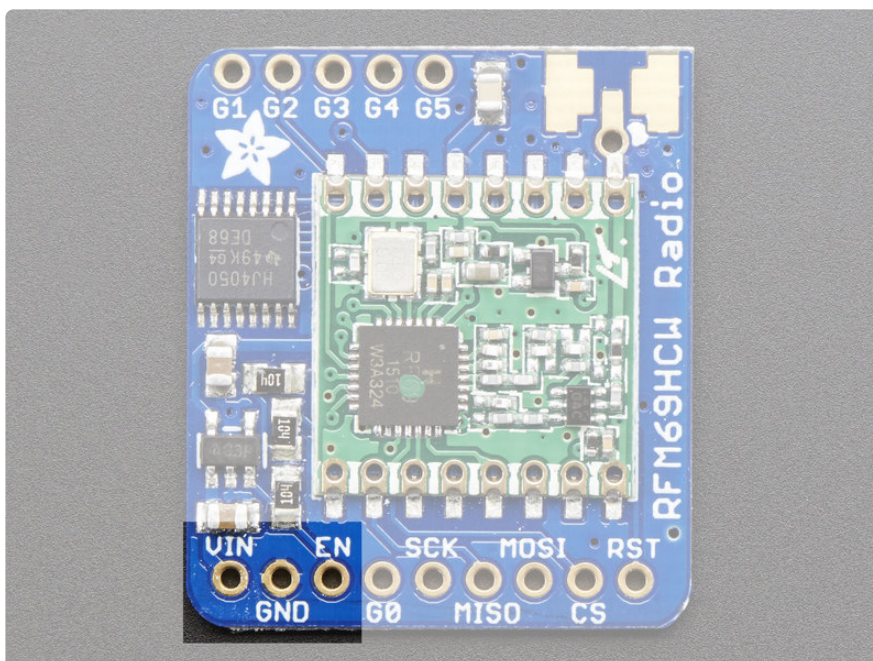

The left-most pins are used for power

- **Vin** - power in. This is regulated down to 3.3V so you can use 3.3-6VDC in. Make sure it can supply 150mA since the peak radio currents can be kinda high
- **GND** - ground for logic and power
- **EN** - connected to the enable pin of the regulator. Pulled high to **Vin** by default, pull low to completely cut power to the radio.

SPI Logic pins:

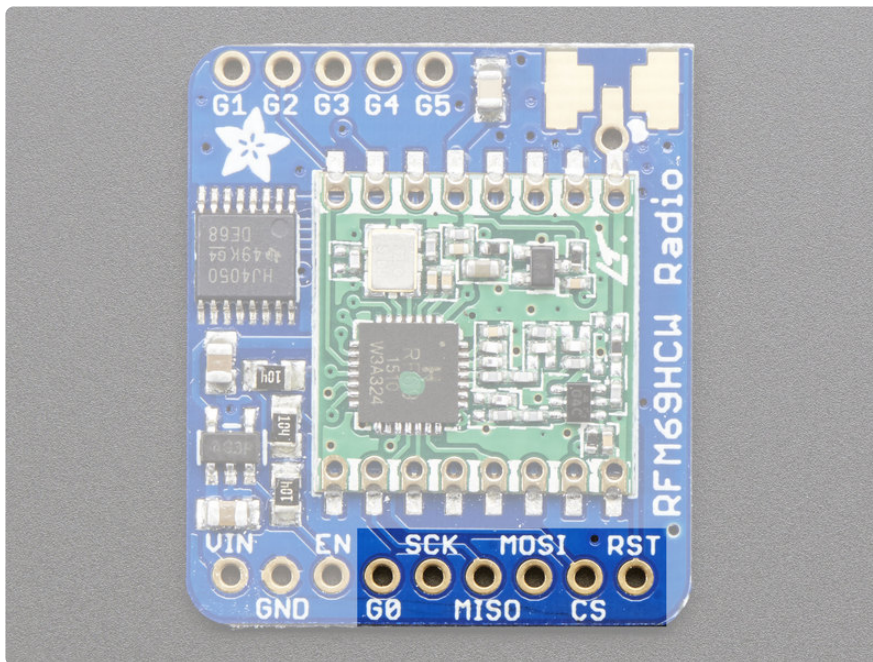

All pins going into the breakout have level shifting circuitry to make them 3-5V logic level safe. Use whatever logic level is on **Vin**!

- **SCK** - This is the **SPI Clock** pin, its an input to the chip
- **MISO** - this is the **Microcontroller In Serial Out** pin, for data sent from the radio to your processor, 3.3V logic level
- **MOSI** - this is the **Microcontroller Out Serial In** pin, for data sent from your processor to the radio
- **CS** - this is the **Chip Select** pin, drop it low to start an SPI transaction. Its an input to the chip
- **RST** - this is the **Reset** pin for the radio. It's pulled high by default which is reset. Pull **LOW** to turn on the radio
- **G0** - the radio's "GPIO 0" pin, also known as the **IRQ** pin, used for interrupt request notification from the radio to the microcontroller, 3.3V logic level

Radio GPIO

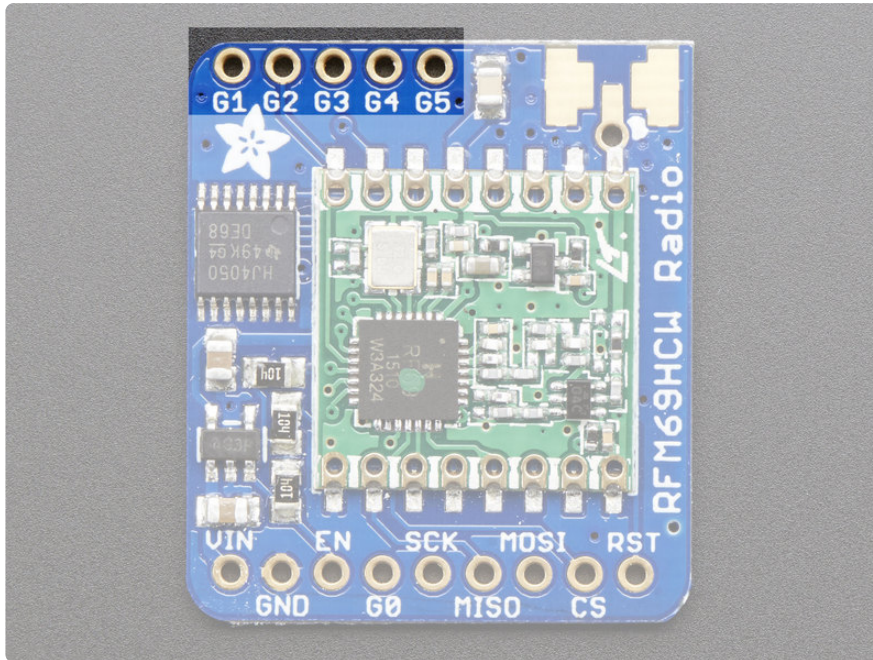

The radio's have another 5 GPIO pins that can be used for various notifications or radio functions. These aren't used for the majority of uses but are available in case you want them! All are 3.3V logic with no level shifting

Antenna Connection

This three-way connection lets you select which kind of Antenna you'd like, from the lowest cost wire dipole to the fanciest SMA

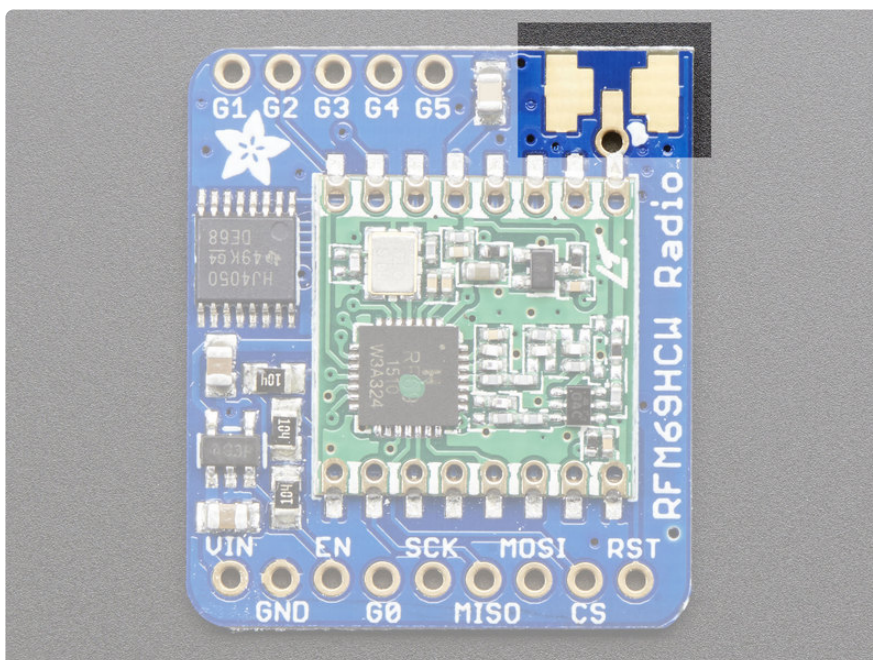

Assembly

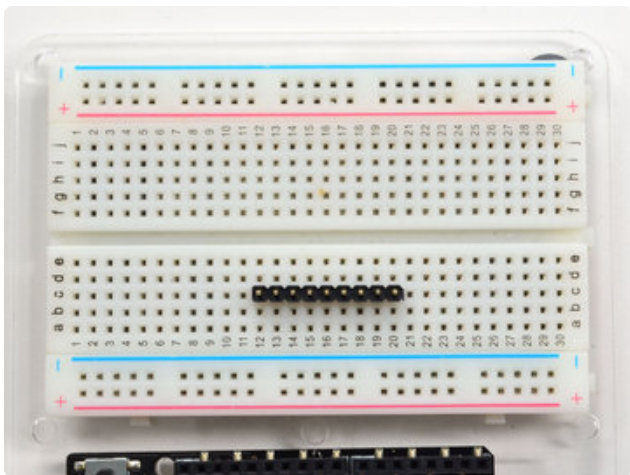
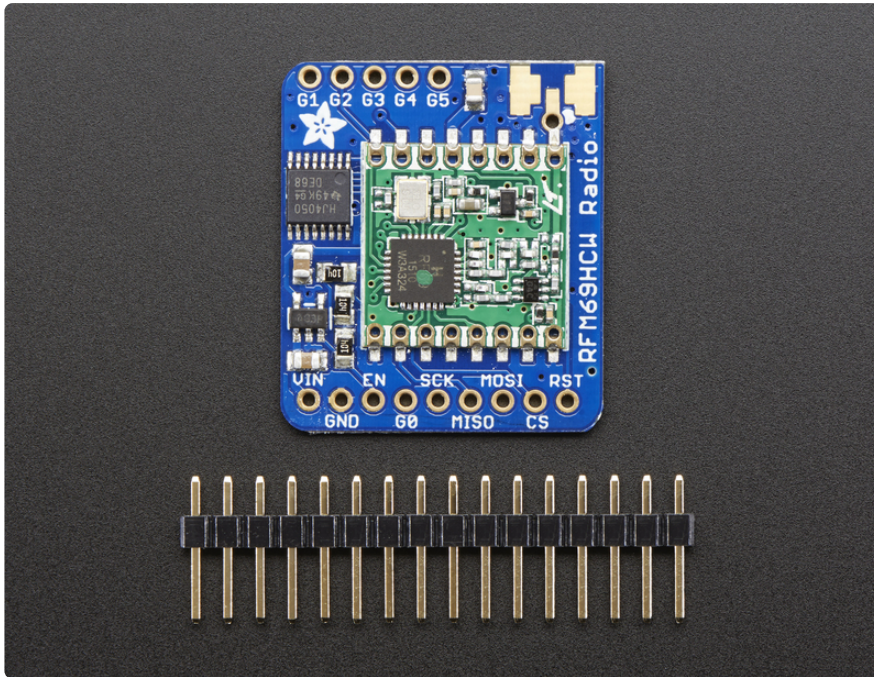

Prepare the header strip:

Cut the strip to length if necessary. It will be easier to solder if you insert it into a breadboard - long pins down

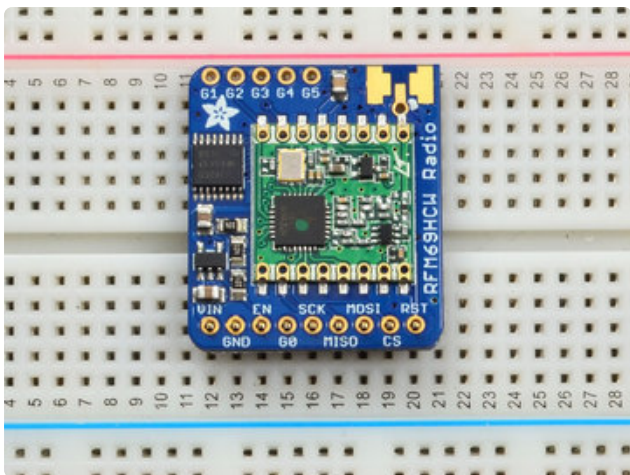

Add the breakout board:

Place the breakout board over the pins so that the short pins poke through the breakout pads

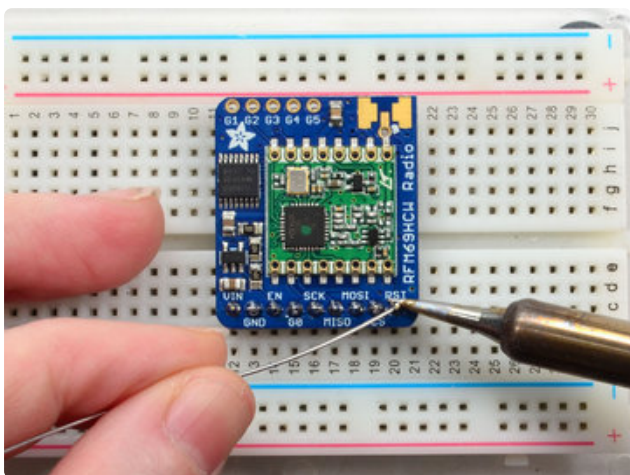
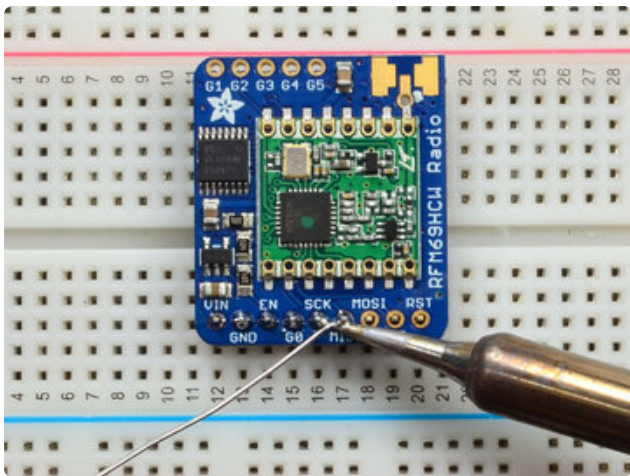
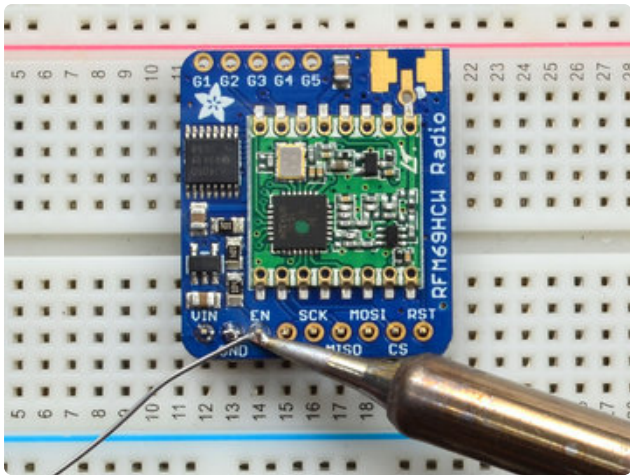
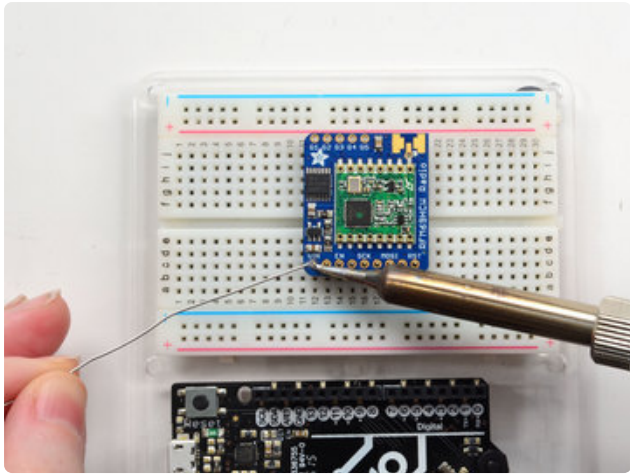

And Solder!

Be sure to solder all pins for reliable electrical contact.

(For tips on soldering, be sure to check out our [Guide to Excellent Soldering \(https://adafruit.it/aTk\)](https://adafruit.it/aTk)).

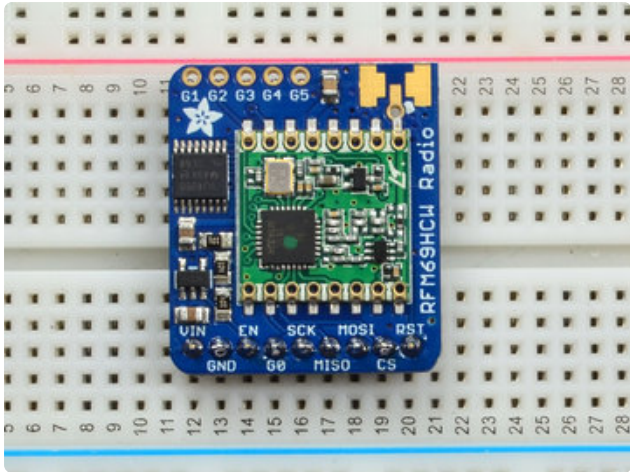

You're done! Check your solder joints visually and continue onto the next steps

Antenna Options

These radio breakouts do not have a built-in antenna. Instead, you have three options for attaching an antenna. For most low cost radio nodes, a wire works great. If you need to put the radio into an enclosure, soldering in uFL and using a uFL to SMA adapter will let you attach an external antenna. You can also solder an SMA edge-mount connector directly

Wire Antenna

A wire antenna, aka "quarter wave whip antenna" is low cost and works very well! You just have to cut the wire down to the right length.

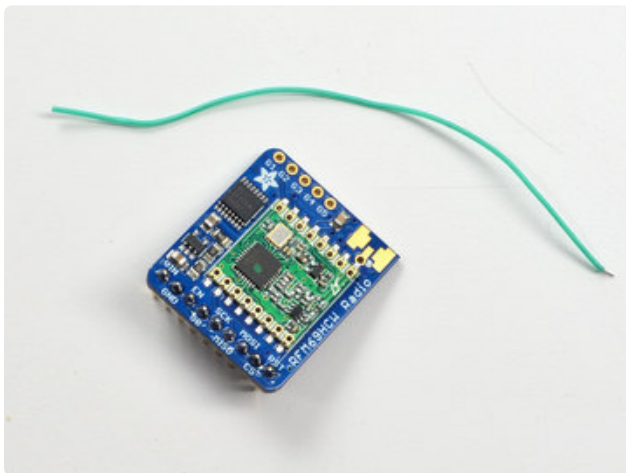

Cut a stranded or solid core wire the the proper length for the module/frequency

433 MHz - 6.5 inches, or 16.5 cm

868 MHz - 3.25 inches or 8.2 cm

915 MHz - 3 inches or 7.8 cm

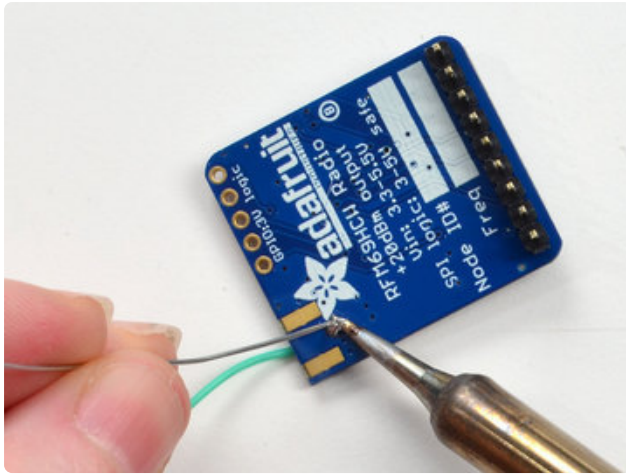

Strip a mm or two off the end of the wire, tin and solder into the **ANT** pad.

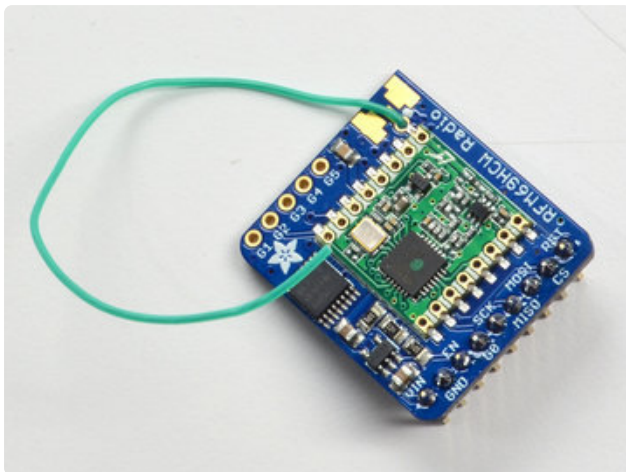

That's pretty much it, you're done!

uFL Connector

If you want an external antenna that is a few inches away from the radio, you need to do a tiny bit more work but its not too difficult.

[You'll need to get an SMT uFL connector, these are fairly standard \(http://adafru.it/1661\)](http://adafru.it/1661)



uFL SMT Antenna Connector

uFL connectors are very small surface-mount parts used when an external RF antenna is desired but a big bulky SMA connector takes up too much space. We use this part on our GPS and WiFi...

<https://www.adafruit.com/product/1661>

You'll also need a [uFL to SMA adapter](http://adafru.it/851) (<http://adafru.it/851>) (or whatever adapter you need for the antenna you'll be using, SMA is the most common



SMA to uFL/u.FL/IPX/IPEX RF Adapter Cable

This RF adapter cable is super handy for anyone doing RF work. Often times, small electronics save space by having a pick-and-placeable u.FL connector (also called uFL, IPEX, IPAX,...

<https://www.adafruit.com/product/851>

Of course, you will also need an antenna of some sort, that matches your radio frequency

uFL connectors are rated for 30 connection cycles, but be careful when connecting/disconnecting to not rip the pads off the PCB. Once a uFL/SMA adapter is connected, use strain relief!

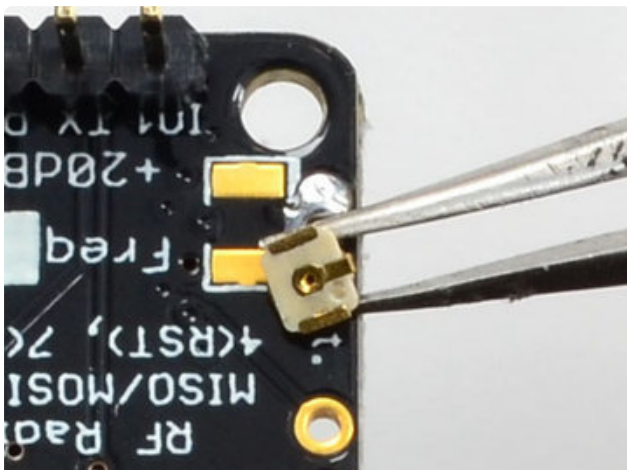

Check the bottom of the uFL connector, note that there's two large side pads (ground) and a little inlet pad. The other small pad is not used!

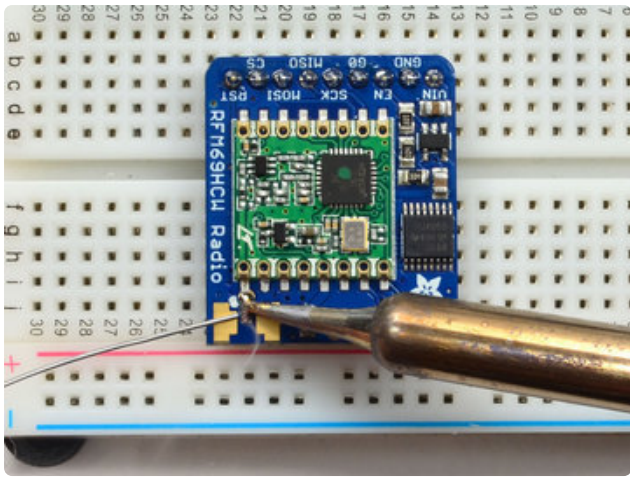

Put down a touch of solder on the signal pad

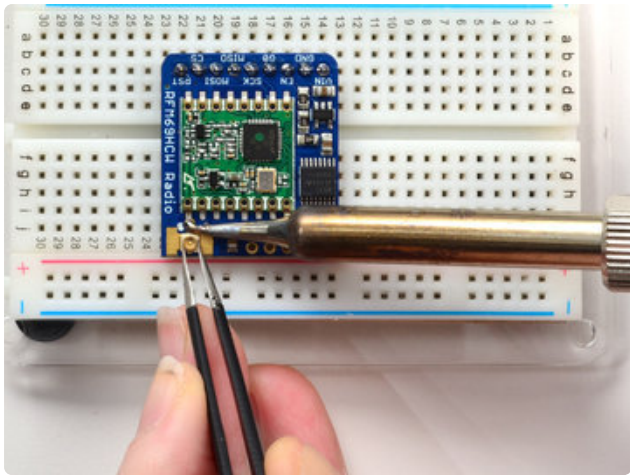

Solder in the first pad while holding the uFL steady

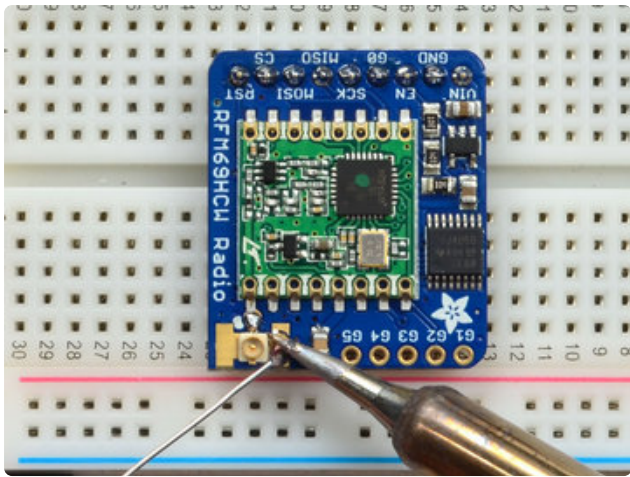

Solder in the two side pads, they are used for signal and mechanical connectivity so make sure there's plenty of solder

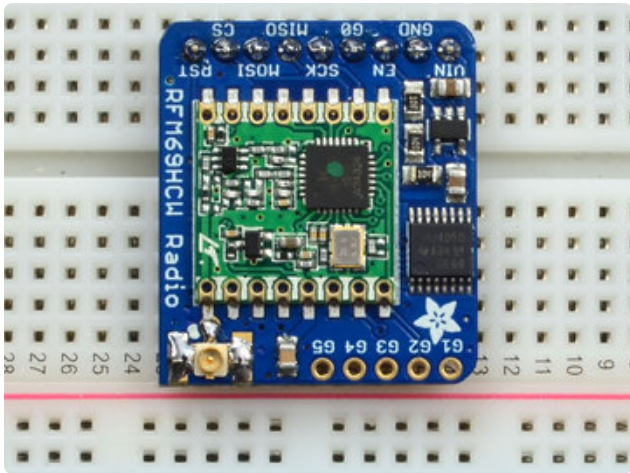
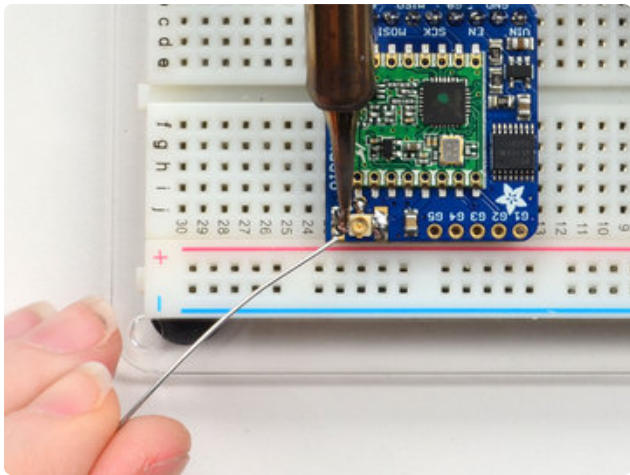

Once done, check your work visually

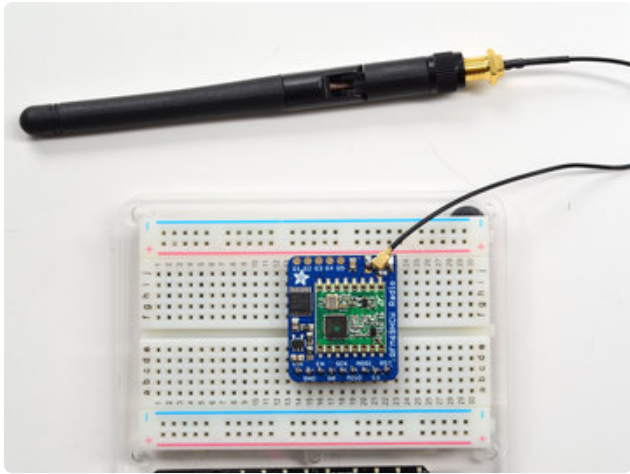

Once done attach your uFL adapter and antenna!

SMA Edge-Mount Connector

OK so

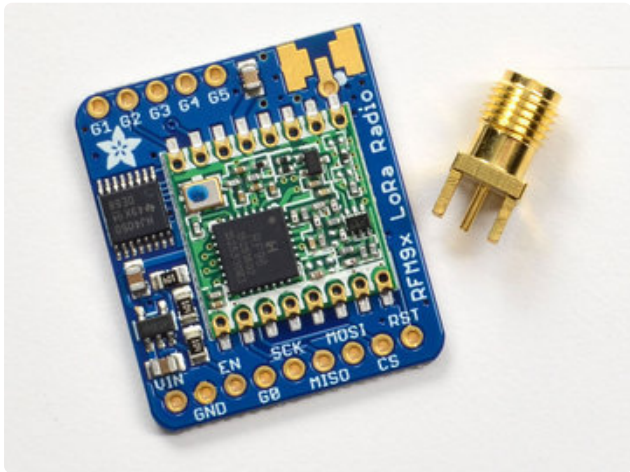

You'll need an SMA (or, if you need RP-SMA for some reason) Edge-Mount connector with 1.6mm spacing



The SMA connector 'slides on' the top of the PCB

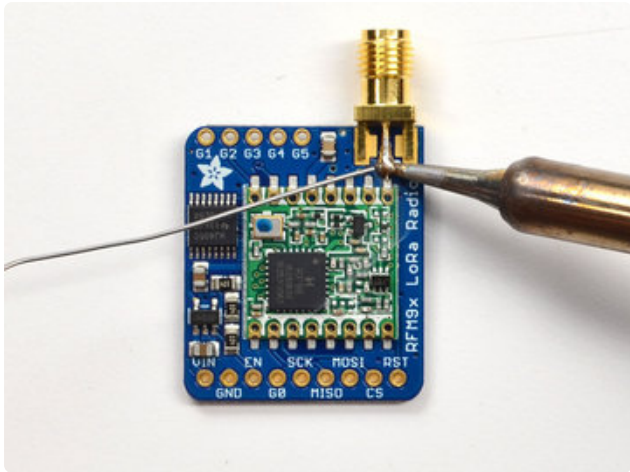

Once lined up, solder the center contact first

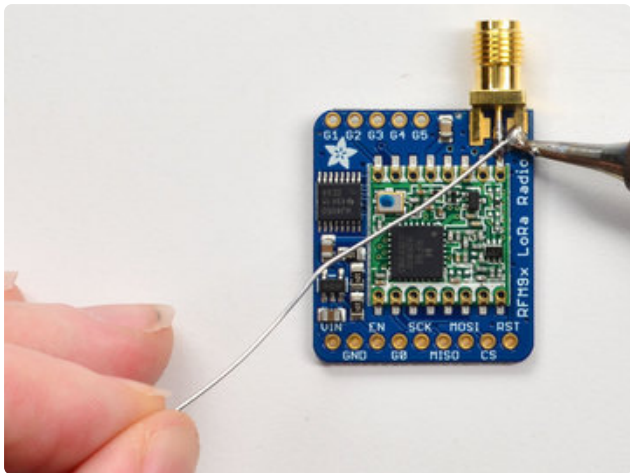

Solder in the two side ground pads. Note you will need a lot of heat for this, because the connector is an excellent heat sink and its got a huge ground plane

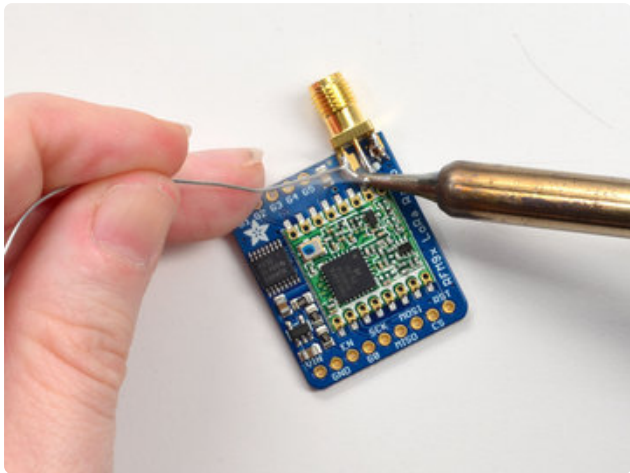

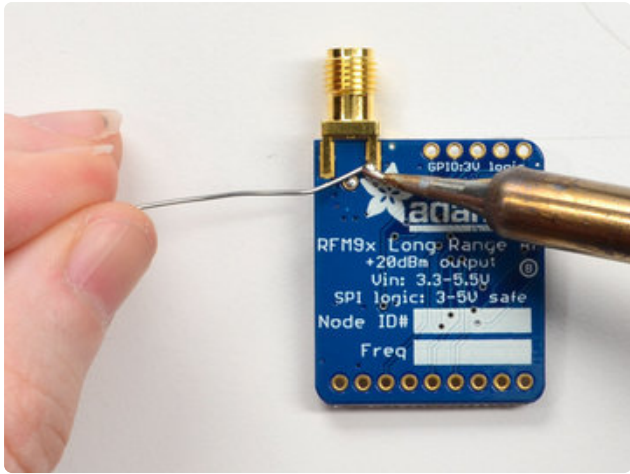

Flip over and also do the other side ground/mechanical contacts

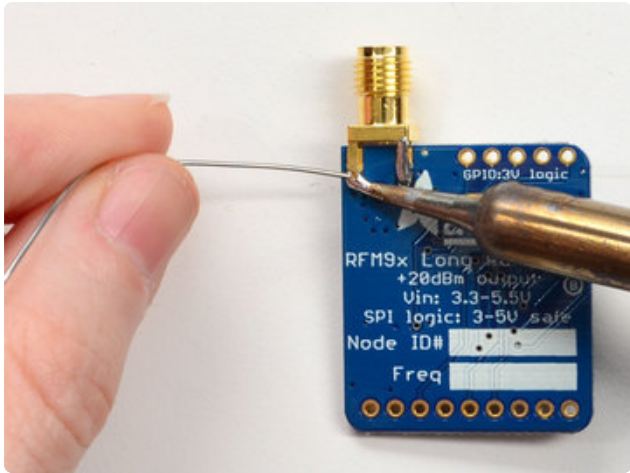



Attach on your antenna, you're done!



Arduino Wiring

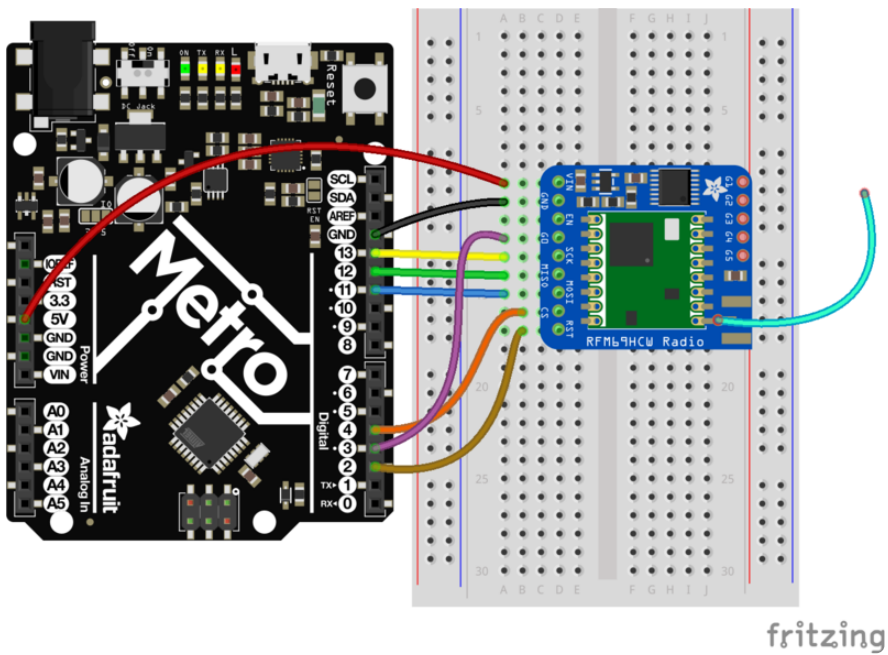

rfm69.fzz

<https://adafruit.it/vhb>

Wiring up the radio in SPI mode is pretty easy as there's not that many pins! The library requires hardware SPI and does not have software SPI support so you must use the hardware SPI port! Start by connecting the power pins

- **Vin** connects to the Arduino **5V** pin. If you're using a 3.3V Arduino, connect to **3.3V**
- **GND** connects to Arduino ground
- **SCLK** connects to SPI clock. On Arduino Uno/Duemilanove/328-based, that's **Digital 13**. On Mega's, it's **Digital 52** and on Leonardo/Due it's **ICSP-3** ([See SPI Connections for more details \(https://adafru.it/d5h\)](https://adafru.it/d5h))
- **MISO** connects to SPI MISO. On Arduino Uno/Duemilanove/328-based, that's **Digital 12**. On Mega's, it's **Digital 50** and on Leonardo/Due it's **ICSP-1** ([See SPI Connections for more details \(https://adafru.it/d5h\)](https://adafru.it/d5h))
- **MOSI** connects to SPI MOSI. On Arduino Uno/Duemilanove/328-based, that's **Digital 11**. On Mega's, it's **Digital 51** and on Leonardo/Due it's **ICSP-4** ([See SPI Connections for more details \(https://adafru.it/d5h\)](https://adafru.it/d5h))
- **CS** connects to our SPI Chip Select pin. We'll be using **Digital 4** but you can later change this to any pin
- **RST** connects to our radio reset pin. We'll be using **Digital 2** but you can later change this pin too.
- **GO (IRQ)** connects to an interrupt-capable pin. We'll be using **Digital 3** but you can later change this pin too. However, **it must connect a hardware Interrupt pin**. Not all pins can do this! Check the board documentation for which pins are hardware interrupts, you'll also need the hardware interrupt number. For example, on UNO digital 3 is interrupt #1

Using the RFM69 Radio

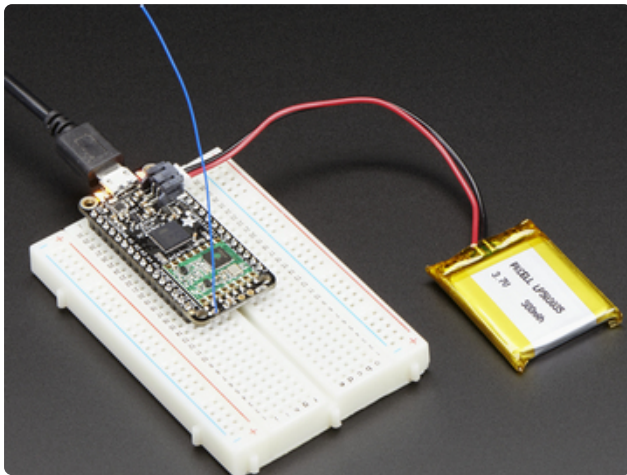
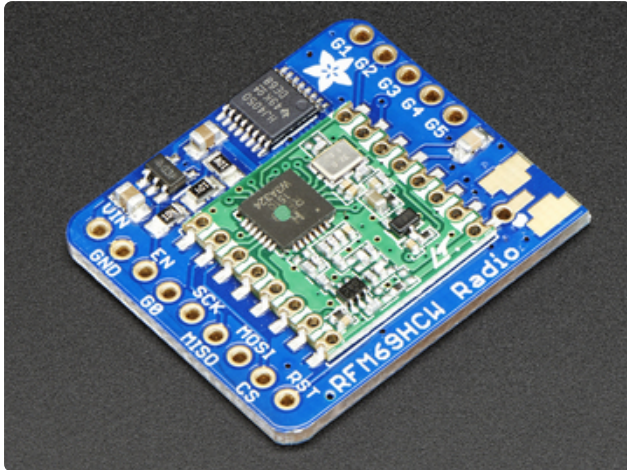

This page is shared between the RFM69 breakout and the all-in-one Feather RFM69's. The example code and overall functionality is the same, only the pinouts used may differ! Just make sure the example code is using the pins you have wired up.

Before beginning make sure you have your Arduino or Feather working smoothly, it will make this part a lot easier. Once you have the basic functionality going - you can upload code, blink an LED, use the serial output, etc. you can then upgrade to using the radio itself.

Note that the sub-GHz radio is not designed for streaming audio or video! It's best used for small packets of data. The data rate is adjustable but its common to stick to around 19.2 Kbps (thats bits per second). Lower data rates will be more successful in their transmissions

You will, of course, need at least two paired radios to do any testing! The radios must be matched in frequency (e.g. two 900 MHz radios are ok, but mixing 900 MHz and 433 MHz is not). They also must use the same encoding schemes, you cannot have a 900 MHz **RFM69** packet radio talk to a 900 MHz **RFM9x LoRa** radio.

"Raw" vs Packetized

The SX1231 can be used in a 'raw rx/tx' mode where it just modulates incoming bits from pin #2 and sends them on the radio, however there's no error correction or addressing so we wont be covering that technique.

Instead, 99% of cases are best off using packetized mode. This means you can set up a recipient for your data, error correction so you can be sure the whole data set was transmitted correctly, automatic re-transmit retries and return-receipt when the packet was delivered. Basically, you get the transparency of a data pipe without the annoyances of radio transmission unreliability

Arduino Libraries

These radios have really great libraries already written, so rather than coming up with a new standard we suggest using existing libraries such as [LowPowerLab's RFM69 Library \(https://adafru.it/mCz\)](https://adafru.it/mCz) and [AirSpayce's Radiohead library \(https://adafru.it/mCA\)](https://adafru.it/mCA) which also supports a vast number of other radios

These are really great Arduino Libraries, so please support both companies in thanks for their efforts!

We recommend using the **Radiohead library** - it is very cross-platform friendly and used a lot in the community!

RadioHead Library example

To begin talking to the radio, you will need to [download our fork of the Radiohead library from our github repository \(https://adafru.it/vgE\)](https://adafru.it/vgE). You can do that by visiting the github repo and manually downloading or, easier, just click this button to download the zip:

[Download RadioHead Library](https://adafru.it/vgF)

<https://adafru.it/vgF>

Rename the uncompressed folder **RadioHead** and check that the **RadioHead** folder contains files like **RH_RF69.cpp** and **RH_RF69.h** (and many others!)

Place the **RadioHead** library folder in your **arduinofolder/libraries/** folder.

You may need to create the **libraries** subfolder if it's your first library. Restart the IDE.

We also have a great tutorial on Arduino library installation at:

<http://learn.adafruit.com/adafruit-all-about-arduino-libraries-install-use> (<https://adafru.it/aYM>)

Basic RX & TX example

Lets get a basic demo going, where one radio transmits and the other receives. We'll start by setting up the transmitter

Basic Transmitter example code

This code will send a small packet of data once a second to another RFM69 radio, without any addressing.

Open up the example **RadioHead**→**feather**→**RadioHead69_RawDemo_TX**

Load this code into your Transmitter Arduino or Feather!

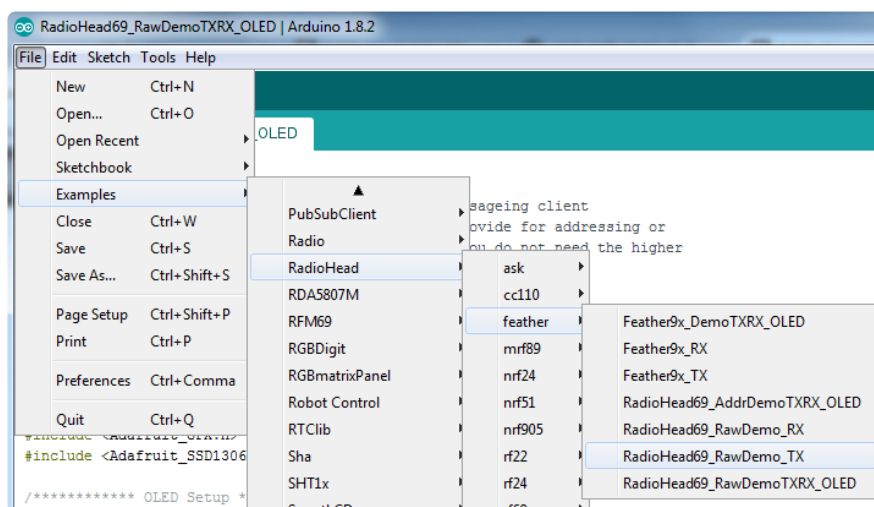

Before uploading, check for the `#define RF69_FREQ` line and edit if necessary to match the frequency of the radio hardware you're using.

These examples are optimized for the Feather 32u4/M0/RP2040. If you're using different wiring (e.g. radio breakout board), uncomment/comment/edit the sections defining the pins depending on which chipset and wiring you are using! The pins used will vary depending on your setup!

Once uploaded you should see the following on the serial console

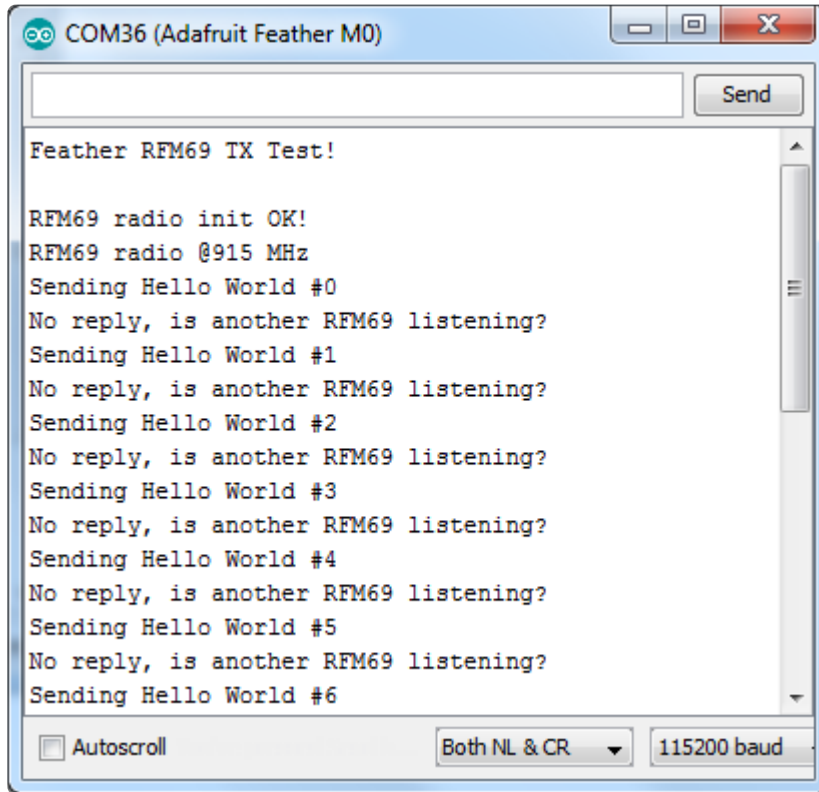

Now open up another instance of the Arduino IDE - this is so you can see the serial console output from the TX device while you set up the RX device.

Basic receiver example code

This code will receive and reply with a small packet of data.

Open up the example **RadioHead**→**feather**→**RadioHead69_RawDemo_RX**

Load this code into your **Receiver** Arduino/Feather!

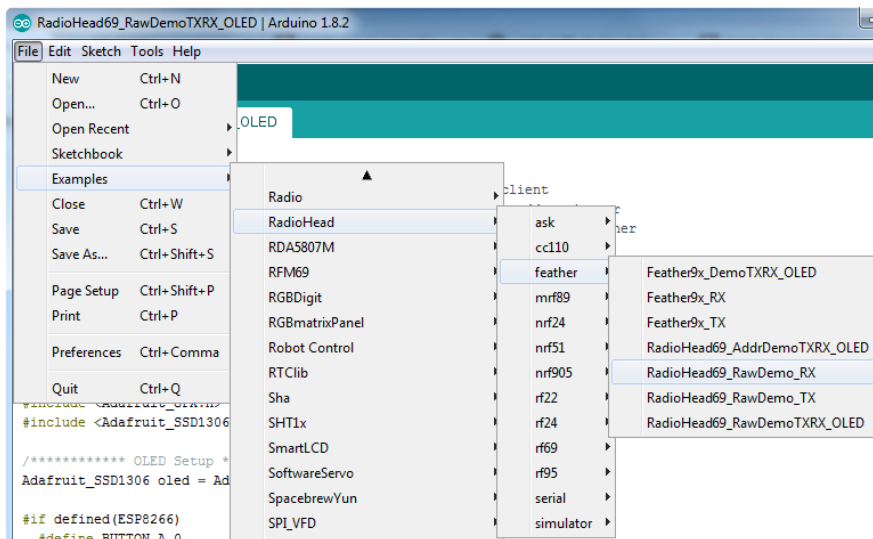

Before uploading, check for the `#define RF69_FREQ` line and edit if necessary to match the frequency of the radio hardware you're using.

These examples are optimized for the Feather 32u4/M0/RP2040. If you're using different wiring (e.g. radio breakout board), uncomment/comment/edit the sections defining the pins depending on which chipset and wiring you are using! The pins used will vary depending on your setup!

Now open up the Serial console on the receiver, while also checking in on the transmitter's serial console. You should see the receiver is...well, receiving packets

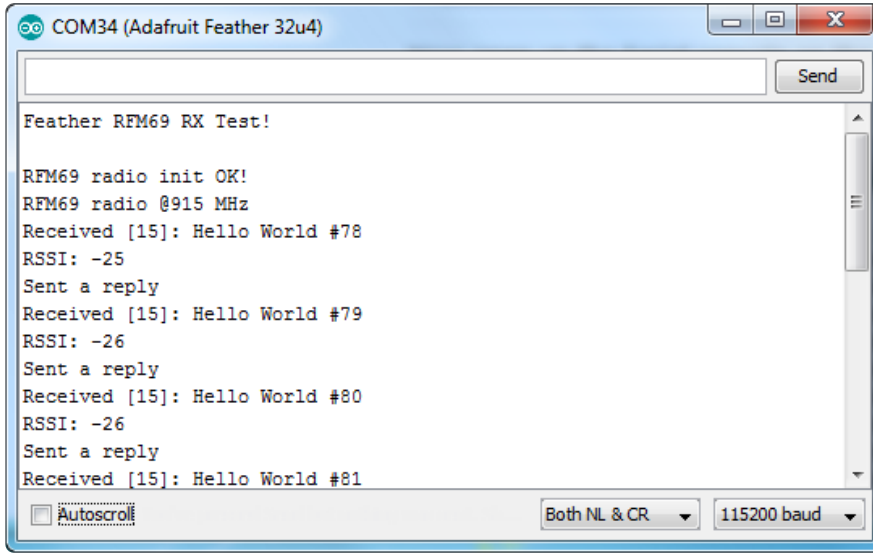

And, on the transmitter side, it is now printing **Got Reply** after each transmission because it got a reply from the receiver

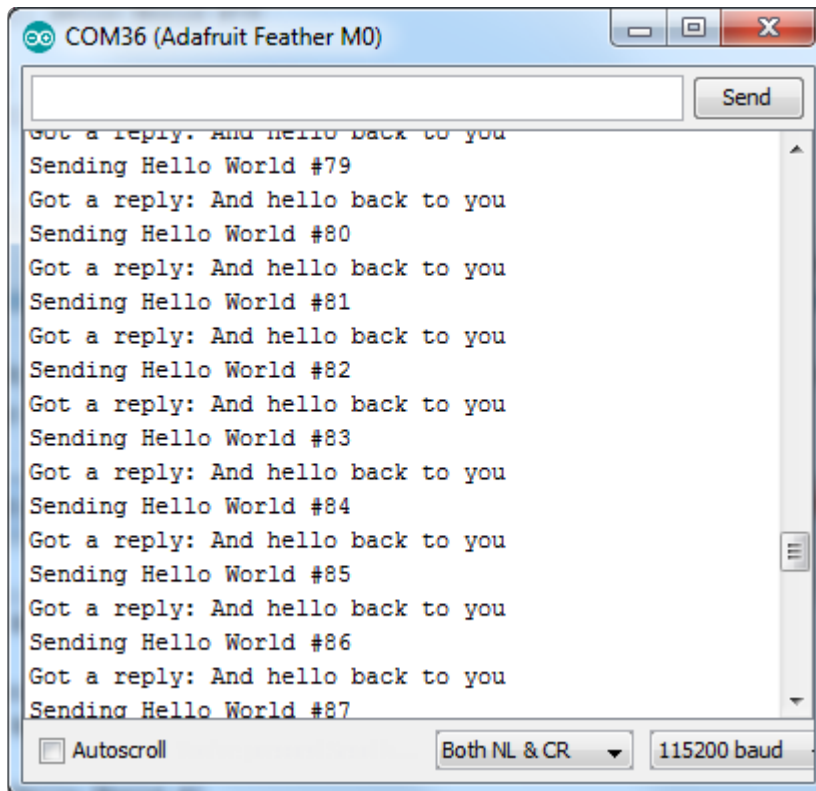

That's pretty much the basics of it! Lets take a look at the examples so you know how to adapt to your own radio network

Radio Freq. Config

Each radio has a frequency that is configurable in software. You can actually tune outside the recommended frequency, but the range won't be good. 900 MHz can be tuned from about 850-950MHz with good performance. 433 MHz radios can be tuned from 400-460 MHz or so.

```
// Change to 434.0 or other frequency, must match RX's freq!  
#define RF69_FREQ 915.0
```

For all radios they will need to be on the same frequency. If you have a 433MHz radio you will want to stick to 433. If you have a 900 Mhz radio, go with 868 or 915MHz, just make sure all radios are on the same frequency.

Configuring Radio Pinout

At the top of the sketch you can also set the pinout. The radios will use hardware SPI, but you can select any pins for **RFM69_CS** (an output), **RFM_IRQ** (an input) and **RFM_RST** (an output). RFM_RST is manually used to reset the radio at the beginning

of the sketch. **RFM_IRQ** must be an interrupt-capable pin. Check your board to determine which pins you can use!

Also, an LED is defined.

For example, here is the Feather 32u4 pinout:

```
#if defined (__AVR_ATmega32U4__) // Feather 32u4 w/Radio
#define RFM69_CS 8
#define RFM69_INT 7
#define RFM69_RST 4
#define LED 13
```

If you're using a Feather M0, the pinout is slightly different:

```
#elif defined(ADAFRUIT_FEATHER_M0) || defined(ADAFRUIT_FEATHER_M0_EXPRESS) ||
defined(ARDUINO_SAMD_FEATHER_M0) // Feather M0 w/Radio
#define RFM69_CS 8
#define RFM69_INT 3
#define RFM69_RST 4
#define LED 13
```

And for Feather RP2040:

```
#elif defined(ARDUINO_ADAFRUIT_FEATHER_RP2040_RFM) // Feather RP2040 w/Radio
#define RFM69_CS 16
#define RFM69_INT 21
#define RFM69_RST 17
#define LED LED_BUILTIN
```

If you're using an Arduino UNO or compatible, we recommend:

```
#elif defined (__AVR_ATmega328P__) // Feather 328P w/wing
#define RFM69_CS 4 //
#define RFM69_INT 3 //
#define RFM69_RST 2 // "A"
#define LED 13
```

If you're using a FeatherWing or different setup, you'll have to set up the **#define** statements to match your wiring

You can then instantiate the radio object with our custom pin numbers. Note that the IRQ is defined by the IRQ pin not number (sometimes they differ).

```
// Singleton instance of the radio driver
RH_RF69 rf69(RFM69_CS, RFM69_INT);
```

Setup

We begin by setting up the serial console and hard-resetting the RFM69

```
void setup()
{
  Serial.begin(115200);
  //while (!Serial) { delay(1); } // wait until serial console is open, remove if
  not tethered to computer

  pinMode(LED, OUTPUT);
  pinMode(RFM69_RST, OUTPUT);
  digitalWrite(RFM69_RST, LOW);

  Serial.println("Feather RFM69 RX Test!");
  Serial.println();

  // manual reset
  digitalWrite(RFM69_RST, HIGH);
  delay(10);
  digitalWrite(RFM69_RST, LOW);
  delay(10);
}
```

If you are using a board with 'native USB' make sure the **while (!Serial)** line is commented out if you are not tethering to a computer, as it will cause the microcontroller to halt until a USB connection is made!

Initializing Radio

Once initialized, you can set up the frequency, transmission power, radio type and encryption key.

For the **frequency**, we set it already at the top of the sketch

For **transmission power** you can select from 14 to 20 dBi. Lower numbers use less power, but have less range. The second argument to the function is whether it is an HCW type radio, with extra amplifier. This should always be set to **true!**

Finally, if you are **encrypting** data transmission, set up the encryption key

```
if (!rf69.init()) {
  Serial.println("RFM69 radio init failed");
  while (1);
}
Serial.println("RFM69 radio init OK!");

// Defaults after init are 434.0MHz, modulation GFSK_Rb250Fd250, +13dbM (for low
power module)
// No encryption
if (!rf69.setFrequency(RF69_FREQ)) {
  Serial.println("setFrequency failed");
}
```

```

// If you are using a high power RF69 eg RFM69HW, you *must* set a Tx power with
the
// ishighpowermodule flag set like this:
rf69.setTxPower(20, true); // range from 14-20 for power, 2nd arg must be true
for 69HCW

// The encryption key has to be the same as the one in the server
uint8_t key[] = { 0x01, 0x02, 0x03, 0x04, 0x05, 0x06, 0x07, 0x08,
                 0x01, 0x02, 0x03, 0x04, 0x05, 0x06, 0x07, 0x08};
rf69.setEncryptionKey(key);

```

Basic Transmission Code

If you are using the transmitter, this code will wait 1 second, then transmit a packet with "Hello World #" and an incrementing packet number, then check for a reply

```

void loop() {
  delay(1000); // Wait 1 second between transmits, could also 'sleep' here!

  char radiopacket[20] = "Hello World #";
  itoa(packetnum++, radiopacket+13, 10);
  Serial.print("Sending "); Serial.println(radiopacket);

  // Send a message!
  rf69.send((uint8_t *)radiopacket, strlen(radiopacket));
  rf69.waitPacketSent();

  // Now wait for a reply
  uint8_t buf[RH_RF69_MAX_MESSAGE_LEN];
  uint8_t len = sizeof(buf);

  if (rf69.waitAvailableTimeout(500)) {
    // Should be a reply message for us now
    if (rf69.recv(buf, &len)) {
      Serial.print("Got a reply: ");
      Serial.println((char*)buf);
      Blink(LED, 50, 3); //blink LED 3 times, 50ms between blinks
    } else {
      Serial.println("Receive failed");
    }
  } else {
    Serial.println("No reply, is another RFM69 listening?");
  }
}

```

Its pretty simple, the delay does the waiting, you can replace that with low power sleep code. Then it generates the packet and appends a number that increases every tx. Then it simply calls `send()` `waitPacketSent()` to wait until is is done transmitting.

It will then wait up to 500 milliseconds for a reply from the receiver with `waitAvailableTimeout(500)` . If there is a reply, it will print it out. If not, it will complain nothing was received. Either way the transmitter will continue the loop and sleep for a second until the next TX.

Basic Receiver Code

The Receiver has the same exact setup code, but the loop is different

```
void loop() {
  if (rf69.available()) {
    // Should be a message for us now
    uint8_t buf[RH_RF69_MAX_MESSAGE_LEN];
    uint8_t len = sizeof(buf);
    if (rf69.recv(buf, &len)) {
      if (!len) return;
      buf[len] = 0;
      Serial.print("Received [");
      Serial.print(len);
      Serial.print("]: ");
      Serial.println((char*)buf);
      Serial.print("RSSI: ");
      Serial.println(rf69.lastRssi(), DEC);

      if (strstr((char *)buf, "Hello World")) {
        // Send a reply!
        uint8_t data[] = "And hello back to you";
        rf69.send(data, sizeof(data));
        rf69.waitPacketSent();
        Serial.println("Sent a reply");
        Blink(LED, 40, 3); //blink LED 3 times, 40ms between blinks
      }
    } else {
      Serial.println("Receive failed");
    }
  }
}
```

Instead of transmitting, it is constantly checking if there's any data packets that have been received. `available()` will return true if a packet with the proper encryption has been received. If so, the receiver prints it out.

It also prints out the RSSI which is the receiver signal strength indicator. This number will range from about -15 to -80. The larger the number (-15 being the highest you'll likely see) the stronger the signal.

If the data contains the text "Hello World" it will also reply to the packet.

Once done it will continue waiting for a new packet

Basic Receiver/Transmitter Demo w/OLED

OK once you have that going you can try this example, **RadioHead69_RawDemoTXRX_OLED**. We're using the Feather with an OLED wing but in theory you can run the code without the OLED and connect three buttons to GPIO #9, 6, and 5 on the Feathers. Upload the same code to each Feather. When you

press buttons on one Feather they will be printed out on the other one, and vice versa. Very handy for testing bi-directional communication!

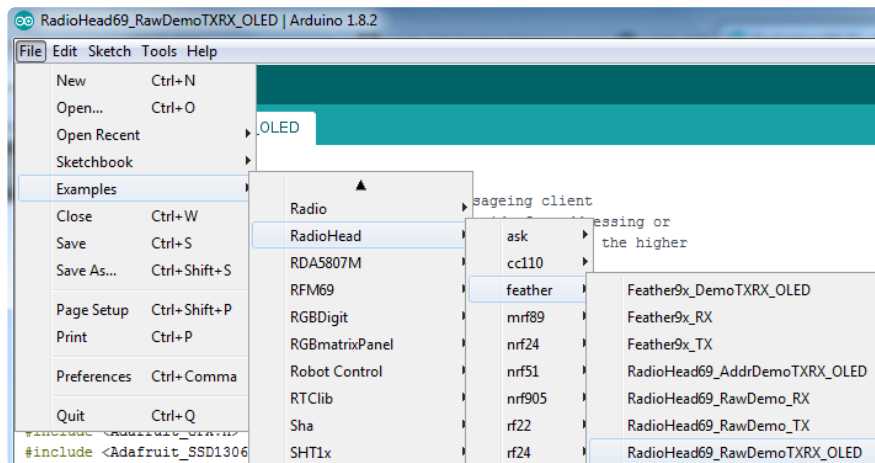

This demo code shows how you can listen for packets and also check for button presses (or sensor data or whatever you like) and send them back and forth between the two radios!

Addressed RX and TX Demo

OK so the basic demo is well and good but you have to do a lot of management of the connection to make sure packets were received. Instead of manually sending acknowledgements, you can have the RFM69 and library do it for you! Thus the **Reliable Datagram** part of the **RadioHead** library.

Load up the **RadioHead69_AddrDemo_RX** and **RadioHead69_AddrDemo_TX** sketches to each of your boards

Remember to check the frequency set in the example, and that the pinouts match your wiring!

This example lets you have many 'client' RFM69's all sending data to one 'server'

Each client can have its own address set, as well as the server address. See this code at the beginning:

```
// Who am i? (server address)
#define MY_ADDRESS 1

// Where to send packets to! MY_ADDRESS in client (RX) should match this.
#define DEST_ADDRESS 2
```

For each client, have a unique **MY_ADDRESS**. Then pick one server that will be address #1

Once you upload the code to a client, you'll see the following in the serial console:

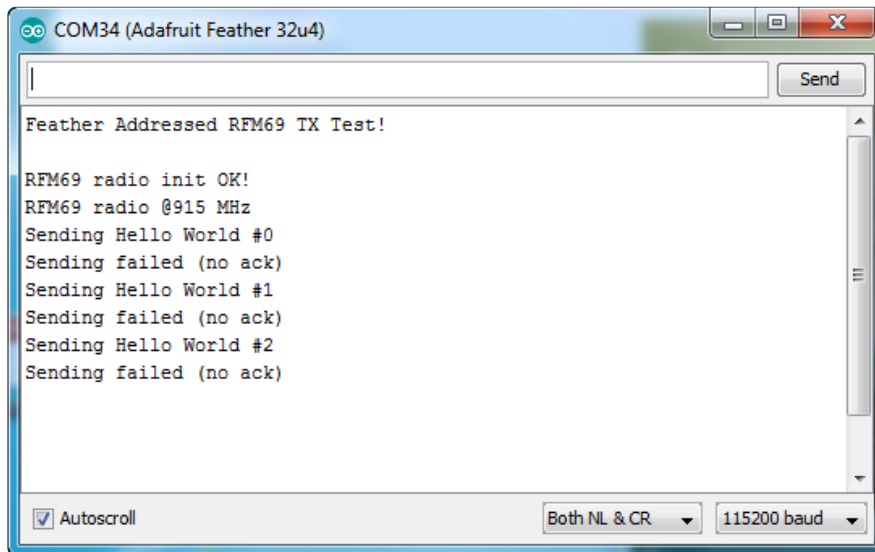

Because the data is being sent to address #1, but #1 is not acknowledging that data.

If you have the server running, with no clients, it will sit quietly:

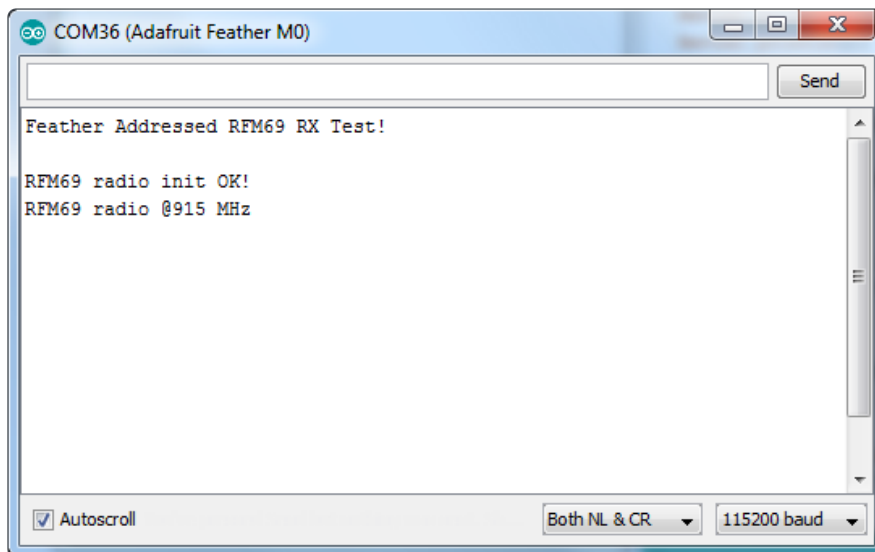

Turn on the client and you'll see acknowledged packets!

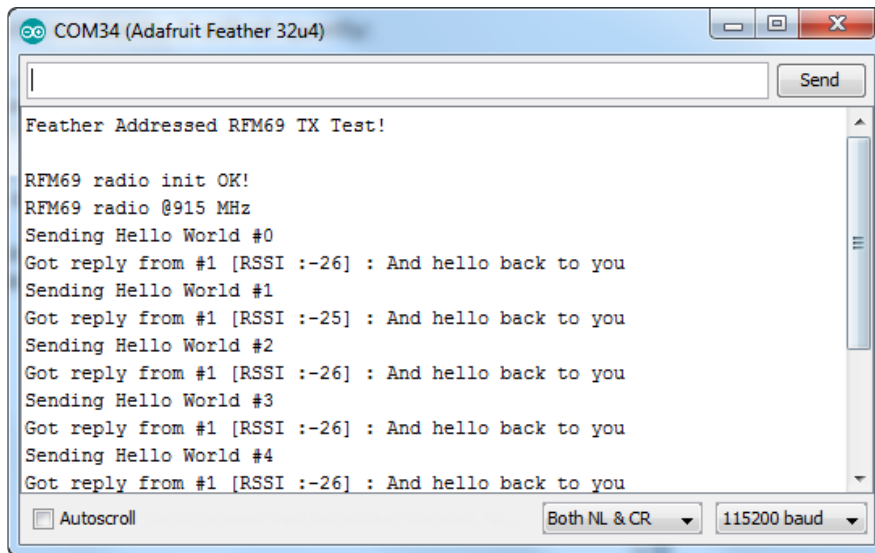

And the server is also pretty happy

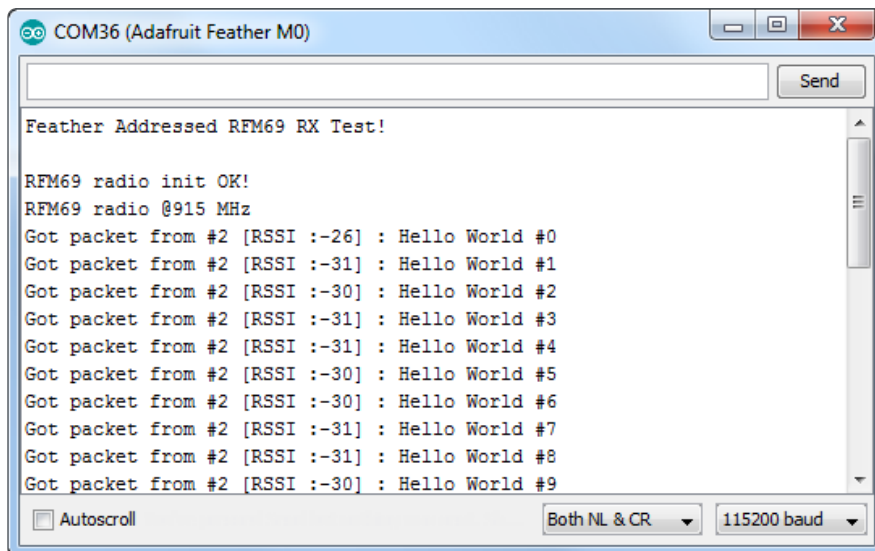

The secret sauce is the addition of this new object:

```
// Class to manage message delivery and receipt, using the driver declared above
RHReliableDatagram rf69_manager(rf69, MY_ADDRESS);
```

Which as you can see, is the manager for the RFM69. In **setup()** you'll need to init it, although you still configure the underlying rfm69 like before:

```
if (!rf69_manager.init()) {
  Serial.println("RFM69 radio init failed");
  while (1);
}
```

And when transmitting, use **sendAndWait** which will wait for an ack from the recipient (at **DEST_ADDRESS**)

```
if (rf69_manager.sendtoWait((uint8_t *)radiopacket, strlen(radiopacket),
DEST_ADDRESS)) {
```

on the 'other side' use the **recvFromAck** which will receive and acknowledge a packet

```
// Wait for a message addressed to us from the client
uint8_t len = sizeof(buf);
uint8_t from;
if (rf69_manager.recvfromAck(buf, &len, &from)) {
```

That function will wait forever. If you'd like to timeout while waiting for a packet, use **recvfromAckTimeout** which will wait an indicated # of milliseconds

```
if (rf69_manager.recvfromAckTimeout(buf, &len, 2000, &from))
```

CircuitPython for RFM69

It's easy to use the RFM69HCW radio with CircuitPython and the [Adafruit CircuitPython RFM69 \(https://adafru.it/BjE\)](https://adafru.it/BjE) module. This module allows you to easily write Python code that sends and receives packets of data with the radio. Be careful to note this library is for the RFM69 radio only and **will not** work with the RFM9X LoRa radios!

Design Considerations

One thing to be aware of before you use the RFM69 series of radios with CircuitPython are some of the limitations and design considerations for its module. Keep these in mind as you think about projects using the RFM69 and CircuitPython:

- You can only send and receive packets up to 60 bytes in length at a time. The size of the radio's internal buffer dictates this limit so if you want to send longer messages you'll need to break them into a series of smaller send calls in your application code.
- Receiving packets is a 'best effort' in pure Python code. Unlike the Arduino versions of the RFM69 library there is no interrupt support which means when a packet is received it must be immediately processed by the Python code or it could be lost. For your application it will work best to only receive small, single packet messages at a time. Don't try to receive kilobytes of data or else you'll lose packets. This module is really intended for simple single packet messages like 'ON', 'OFF', etc.
- Sending and receiving packets will 'block' your Python code until the packet is fully processed. This means you can't do a lot of other things while sending and

waiting for packets to be received. Design your application so the radio usage is the primary scenario and very little other tasks need to happen in the background.

- The module is written to be compatible with the RadioHead RFM69 Arduino library. This means by default the module will setup the radio with the same GFSK, 250kbit/s, 250khz deviation, and bit whitening radio configuration so it can send and receive data with itself and other RadioHead-driven modules. In addition the CircuitPython module uses the same sync word and packet preamble (4 bytes) as RadioHead. If you want to use different modulations or settings you'll need to configure the radio yourself (see [the initialization code \(https://adafru.it/BjF\)](https://adafru.it/BjF) for the registers and bits to access, however you will need to consult the datasheet for the necessary values).
- You can enable encryption and set an AES encryption key.
- The CircuitPython module supports advanced RadioHead features like node addressing and "reliable DataGram". "Reliable DataGram" mode in CircuitPython has some additional parameters to control timing that are not available with the RadioHead library. It may be difficult to get reliable transmission to work between the RadioHead library and CircuitPython.

Wiring With Breakout

First wire up a RFM69 breakout to your board as shown on the previous pages for Arduino. Note that the GO/interrupt line is not used by the CircuitPython module and can remain unconnected. Here's an example of wiring a Feather M0 to the radio with a SPI connection:

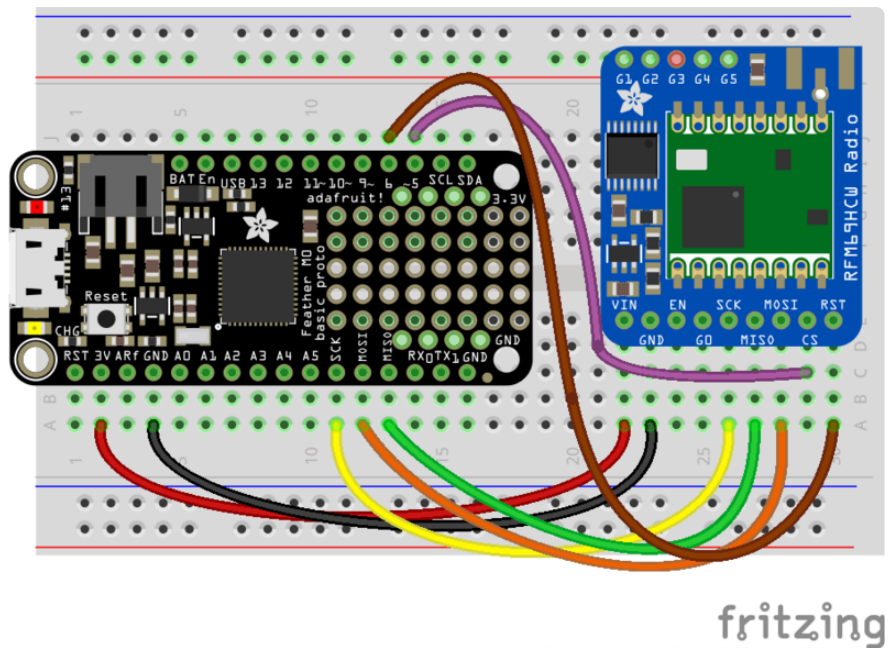

- Board 3V to radio VIN
- Board GND to radio GND
- Board SCK to radio SCK
- Board MOSI to radio MOSI
- Board MISO to radio MISO
- Board D5 to radio CS (or any other digital I/O pin)
- Board D6 to radio RST (or any other digital I/O pin)

Usage with All-In-One Feather M0

Alternatively you can use the Feather M0 RFM69 board but be sure you've loaded the [adafruit-circuitpython-feather_m0_rfm69-*.bin](https://adafru.it/tBa) (<https://adafru.it/tBa>) version of CircuitPython on your board! This is very important as the RFM69 build has special pins added to the board module which are used to access the radio's control lines!

[For details on how to load a binary circuitpython build, check out our Non-UF2-Install guide](https://adafru.it/Bed) (<https://adafru.it/Bed>)

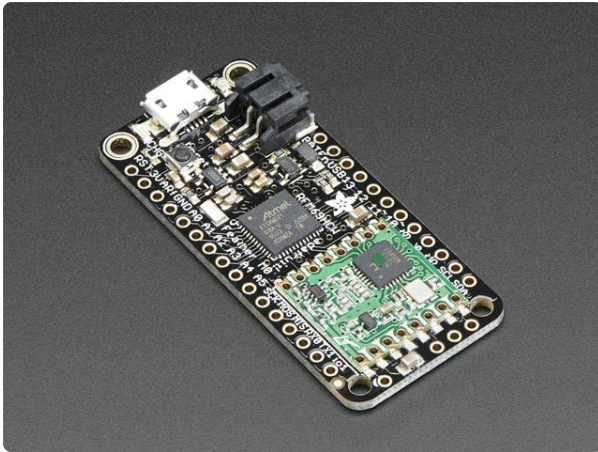

[Adafruit Feather M0 RFM69HCW Packet Radio - 868 or 915 MHz](https://www.adafruit.com/product/3176)

This is the Adafruit Feather M0 RFM69 Packet Radio (868 or 915 MHz). We call these RadioFruits, our take on an...

<https://www.adafruit.com/product/3176>

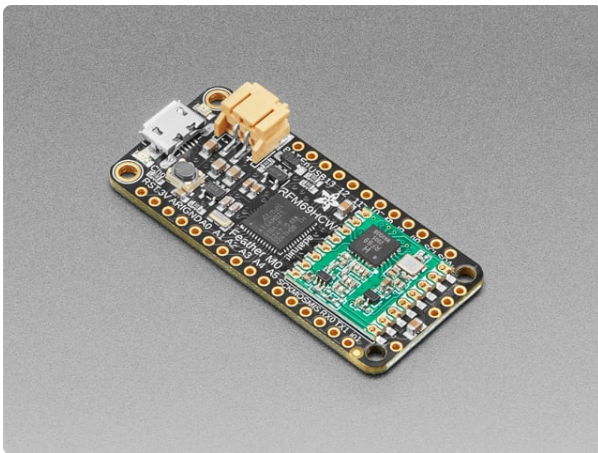

[Adafruit Feather M0 RFM69HCW Packet Radio - 433MHz](https://www.adafruit.com/product/3177)

This is the Adafruit Feather M0 RFM69 Packet Radio (433 MHz). We call these RadioFruits, our take on an...

<https://www.adafruit.com/product/3177>

Module Install

If you have the Feather M0 RFM69 and have installed CircuitPython 6.0 or later, it is not necessary to install the library modules. They are "frozen into" the Circuitpython build. Skip to the "Usage" section below.

If you are using an older version of CircuitPython you will need to install the modules as described.

Next you'll need to install the [Adafruit CircuitPython RFM69 \(https://adafru.it/BjE\)](https://adafru.it/BjE) module on your CircuitPython board. Before you do that make sure you are running the [latest version of Adafruit CircuitPython \(https://adafru.it/Amd\)](https://adafru.it/Amd) for your board too (again be sure to the load the Feather M0 RFM69 version if you're using that board and want to use its built-in radio module).

Next you'll need to install the necessary libraries to use the hardware--carefully follow the steps to find and install these libraries from [Adafruit's CircuitPython library bundle \(https://adafru.it/zdx\)](https://adafru.it/zdx). Our introduction guide has [a great page on how to install the library bundle \(https://adafru.it/ABU\)](https://adafru.it/ABU) for both express and non-express boards.

Remember for non-express boards like the Adafruit Feather M0, you'll need to manually install the necessary libraries from the bundle:

- `adafruit_rfm69.mpy`
- `adafruit_bus_device`

You can also download the `adafruit_rfm69.mpy` from [its releases page on Github \(https://adafru.it/BI2\)](https://adafru.it/BI2).

Before continuing make sure your board's lib folder or root filesystem has the `adafruit_rfm69.mpy`, and `adafruit_bus_device` files and folders copied over.

Usage

To demonstrate the usage of the radio we'll initialize it and send and receive data from the board's Python REPL.

[Connect to the board's serial REPL \(https://adafru.it/Awz\)](https://adafru.it/Awz) so you are at the CircuitPython >>> prompt.

Run the following code to import the necessary modules and initialize the SPI connection with the sensor:

```
import board
import busio
import digitalio
spi = busio.SPI(board.SCK, MOSI=board.MOSI, MISO=board.MISO)
```

Now define a few of the pins connected to the RFM69, specifically the CS and RST pins:

```
cs = digitalio.DigitalInOut(board.D5)
reset = digitalio.DigitalInOut(board.D6)
```

However if you're using the Feather M0 RFM69 board with a built-in RFM69 radio (and you've loaded the special version of CircuitPython just for this board as mentioned above), you instead want to use these pins for the CS and RST lines:

```
cs = digitalio.DigitalInOut(board.RFM69_CS)
reset = digitalio.DigitalInOut(board.RFM69_RST)
```

You're ready to import the RFM69 module and create an instance of the RFM69 class inside it. Before you create the radio module instance you'll need to check if you're using a 433mhz or 915mhz radio module as the initializer requires the frequency to be specified--confirm which frequency your module uses and run **one** of the following lines.

For a 915mhz radio use:

```
import adafruit_rfm69
rfm69 = adafruit_rfm69.RFM69(spi, cs, reset, 915.0)
```

Or for a 433mhz radio use:

```
import adafruit_rfm69
rfm69 = adafruit_rfm69.RFM69(spi, cs, reset, 433.0)
```

Notice the initializer takes the following required parameters:

- **spi** - The SPI bus connected to the board.
- **cs** - The DigitalInOut instance connected to the CS line of the radio.
- **reset** - The DigitalInOut instance connected to the RST or reset line of the radio.
- **frequency** - The frequency in megahertz of the radio module. Remember this frequency depends on which type of radio you're using and the frequency you desire to use!

In addition there are some optional parameters you might specify:

- **baudrate** - The baud rate to use for the SPI connection to the radio. By default this is 10mhz which is as fast as the radio can handle, but in some cases it might be too fast if you're wiring up a breakout to a breadboard (breadboards can be notorious for not working well with high speed signals). If you run into odd errors like being unable to find the RFM69 radio try lowering the baudrate by specifying a **baudrate=1000000** keyword (which sets the speed to a lower 1mhz value).

Once the RFM69 class is created and initialized you're ready to start sending and receiving data.

Remember by default the module will be configured to interface with the "RadioHead" RFM69 setup so you can also send and receive packets with an Arduino running the 'raw' TX/RX examples!

To send a message simply call the **send** function and provide a string or byte string of data:

```
rfm69.send('Hello world!')
```

Remember you can only send a message up to 60 bytes in length at a time!

Attempting to send a message longer than 60 bytes will fail with an exception error. If you need to send a longer message it will have to be broken up into multiple send calls and reconstructed on the receiving side.

If you have another RFM69 on the same frequency and modulation waiting to receive messages (like another CircuitPython module running receive code below) you should see it receive the message.

```
Received nothing! Listening again...
Received nothing! Listening again...
Received (raw bytes): bytearray(b'Hello world!\r\n')
Received (ASCII): Hello world!

Received nothing! Listening again...
Received nothing! Listening again...
```

You can even have an Arduino running the RadioHead library's raw RX example see the message that was sent (be sure this receiving side has an encryption key setup exactly the same way as the sending side, see the **encryption_key** property discussion further below):

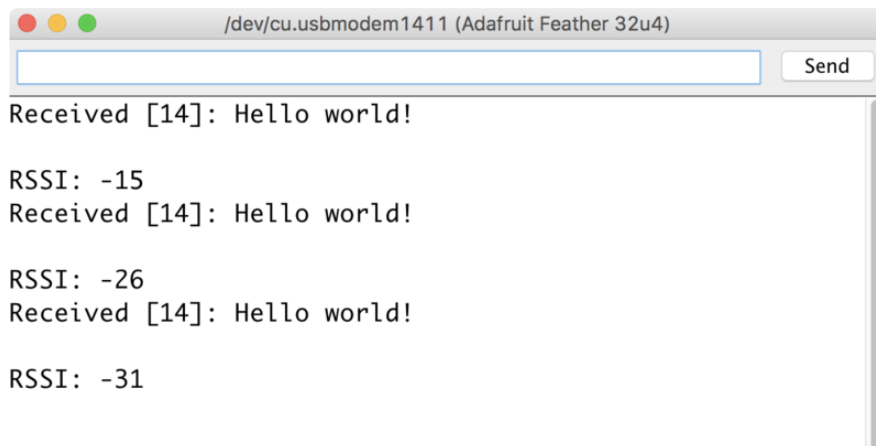

To receive a message simply call the **receive** function. This function will wait for half a second for any packet to be received. If a packet is found it will be returned as a byte string (remember packets are at most 60 bytes long), or if no packet was found a result of **None** is returned.

```
rfm69.receive()
```

You can increase the amount of time the module waits for a packet to be received by specifying the time in seconds as a parameter to the receive call:

```
rfm69.receive(timeout=5.0) # Wait 5 seconds instead of 0.5 seconds.
```

Notice this waits longer at the REPL for a packet to be received before returning. If you have another RFM69 setup try having it send a message while the other is waiting to receive it. You should see a byte string returned. You can also have an Arduino running the RadioHead library's raw TX example send messages that are received by your code (again it must be setup with the same encryption key):

```
Received nothing! Listening again...
Received nothing! Listening again...
Received (raw bytes): bytearray(b'Hello World #2')
Received (ASCII): Hello World #2
Received nothing! Listening again...
Received nothing! Listening again...
Received (raw bytes): bytearray(b'Hello World #3')
Received (ASCII): Hello World #3
Received nothing! Listening again...
Received nothing! Listening again...
Received (raw bytes): bytearray(b'Hello World #4')
Received (ASCII): Hello World #4
Received nothing! Listening again...
Received nothing! Listening again...
Received (raw bytes): bytearray(b'Hello World #5')
Received (ASCII): Hello World #5
Received nothing! Listening again...
Received nothing! Listening again...
```

One thing to note in Python byte strings aren't exactly like text strings and you might not be able to do all the text processing (like find, replace, etc.) as you expect.

However you can convert a byte string into text by assuming a specific text encoding like ASCII. For example to receive a packet and convert the contents to an ASCII text string you can run code like:

```
packet = rfm69.receive() # Wait for a packet to be received (up to 0.5 seconds)
if packet is not None:
    packet_text = str(packet, 'ascii')
    print('Received: {}'.format(packet_text))
```

Notice this code first receives a packet, then checks if one was actually found (the packet is `not None` check--if no packet is received a value of `None` is returned), and then converts the packet data to a string assuming an ASCII text encoding.

Beyond RX & TX

Beyond basic sending and receiving there are a few properties of the RFM69 class you might want to interact with:

- **encryption_key** - This is an optional 16 byte string that defines the AES encryption key used by the radio for sending and receiving packets. Both the sending and receiving code must have the exact same encryption key set or they'll be unable to see each other's packets! See the [simplestest.py example \(https://adafru.it/BI3\)](https://adafru.it/BI3) below for an example of setting the **encryption_key** to match the default key from RadioHead library raw examples. By default the RFM69 class assumes no encryption key is set, and you can set this property to the value **None** to disable encryption.
- **rss_i** - The received signal strength indicator is a property you can read to see the strength of the radio signal being received. This is updated when packets are received and returns a value in decibels (typically negative, so the smaller the number and closer to 0, the higher the strength / better the signal).

```
>>> rfm69.encryption_key = b'\x01\x02\x03\x04\x05\x06\x07\x08\x09\x0a\x0b\x0c\x0d\x0e\x0f'
>>> rfm69.receive(timeout_s=5.0)
bytearray(b'Hello World #309')
```

```
>>> rfm69.rssi
-25.5
>>>
```

That's all there is to the basic RFM69 radio usage! Remember the CircuitPython module is designed for sending and receiving small up to 60 byte control messages and not large or high bandwidth amounts of data.

Here's a complete example of sending a message and waiting to receive and print any received messages. Save this as **main.py** on your board and open the serial REPL to see it print data and any received messages. If you have two boards and radios setup to run this code at the same time they'll send each other a message on start up!

```
# SPDX-FileCopyrightText: 2018 Tony DiCola for Adafruit Industries
# SPDX-License-Identifier: MIT

# Simple example to send a message and then wait indefinitely for messages
# to be received. This uses the default RadioHead compatible GFSK_Rb250_Fd250
# modulation and packet format for the radio.
import board
import busio
import digitalio

import adafruit_rfm69
```

```

# Define radio parameters.
RADIO_FREQ_MHZ = 915.0 # Frequency of the radio in Mhz. Must match your
# module! Can be a value like 915.0, 433.0, etc.

# Define pins connected to the chip, use these if wiring up the breakout according
# to the guide:
CS = digitalio.DigitalInOut(board.D5)
RESET = digitalio.DigitalInOut(board.D6)
# Or uncomment and instead use these if using a Feather M0 RFM69 board
# and the appropriate CircuitPython build:
# CS = digitalio.DigitalInOut(board.RFM69_CS)
# RESET = digitalio.DigitalInOut(board.RFM69_RST)

# Define the onboard LED
LED = digitalio.DigitalInOut(board.D13)
LED.direction = digitalio.Direction.OUTPUT

# Initialize SPI bus.
spi = busio.SPI(board.SCK, MOSI=board.MOSI, MISO=board.MISO)

# Initialize RFM radio
rfm69 = adafruit_rfm69.RFM69(spi, CS, RESET, RADIO_FREQ_MHZ)

# Optionally set an encryption key (16 byte AES key). MUST match both
# on the transmitter and receiver (or be set to None to disable/the default).
rfm69.encryption_key = (
    b"\x01\x02\x03\x04\x05\x06\x07\x08\x01\x02\x03\x04\x05\x06\x07\x08"
)

# Print out some chip state:
print("Temperature: {0}C".format(rfm69.temperature))
print("Frequency: {0}mhz".format(rfm69.frequency_mhz))
print("Bit rate: {0}kbit/s".format(rfm69.bitrate / 1000))
print("Frequency deviation: {0}hz".format(rfm69.frequency_deviation))

# Send a packet. Note you can only send a packet up to 60 bytes in length.
# This is a limitation of the radio packet size, so if you need to send larger
# amounts of data you will need to break it into smaller send calls. Each send
# call will wait for the previous one to finish before continuing.
rfm69.send(bytes("Hello world!\r\n", "utf-8"))
print("Sent hello world message!")

# Wait to receive packets. Note that this library can't receive data at a fast
# rate, in fact it can only receive and process one 60 byte packet at a time.
# This means you should only use this for low bandwidth scenarios, like sending
# and receiving a single message at a time.
print("Waiting for packets...")
while True:
    packet = rfm69.receive()
    # Optionally change the receive timeout from its default of 0.5 seconds:
    # packet = rfm69.receive(timeout=5.0)
    # If no packet was received during the timeout then None is returned.
    if packet is None:
        # Packet has not been received
        LED.value = False
        print("Received nothing! Listening again...")
    else:
        # Received a packet!
        LED.value = True
        # Print out the raw bytes of the packet:
        print("Received (raw bytes): {0}".format(packet))
        # And decode to ASCII text and print it too. Note that you always
        # receive raw bytes and need to convert to a text format like ASCII
        # if you intend to do string processing on your data. Make sure the
        # sending side is sending ASCII data before you try to decode!
        packet_text = str(packet, "ascii")
        print("Received (ASCII): {0}".format(packet_text))

```

Advanced CircuitPython RFM69 Library Usage

RadioHead Header

Every packet transmitted via the CircuitPython RFM9x Library contains a 4 byte header compatible with the Arduino RadioHead Library.

<https://www.airspayce.com/mikem/arduino/RadioHead/classRHGenericDriver.html> (<https://adafru.it/LAa>)

Each message sent and received by a RadioHead driver includes 4 headers:

- TO - the node address that the message is being sent to (broadcast RH_BROADCAST_ADDRESS (255) is permitted)
- FROM - the node address of the sending node
- ID - a message ID, distinct (over short time scales) for each message sent by a particular node
- FLAGS- a bitmask of flags. The most significant 4 bits are reserved for use by RadioHead. The least significant 4 bits are reserved for applications.

For basic usage the TO and FROM addresses are set to "Broadcast" with a value of 255 (0xff) and the ID and FLAGS parameters are ignored. With these settings any packet received will be accepted.

Radiohead Packet Header (4 bytes)

Byte 0				
TO — destination node for this packet (255 = Broadcast to ALL)				
Byte 1				
FROM — origin node for this packet (255 = Broadcast message - origin unknown)				
Byte 2				
ID - Identifier — contains sequence counter for Reliable Datagram Mode - User defined for other modes				
Byte 3				
Bit 7	Bit 6	Bit 5	Bit 4	Bits 3-0
1 = ACK Packet 0= Normal Packet	1 = RETRY 0 = First attempt	RESERVED	RESERVED	User definable

Node Addressing

In many applications, it will be desirable to limit packets received to those originating at specified nodes and to direct responses to particular nodes. This can be controlled by setting the "node" and "destination" attributes for the rfm9x instance created in your CircuitPython code. <https://circuitpython.readthedocs.io/projects/rfm69/en/latest/api.html> (<https://adafru.it/LAb>)

This example demonstrates the usage of the RadioHead Header settings to specify the address of the transmitting and receiving nodes.

This script is to be run on the board designated as Node 1. It will transmit a packet to Node 2 every 10 seconds

```
# Example to send a packet periodically between addressed nodes
# Author: Jerry Needell
#
import time
import board
import busio
import digitalio
import adafruit_rfm69

# set the time interval (seconds) for sending packets
transmit_interval = 10

# Define radio parameters.
RADIO_FREQ_MHZ = 915.0 # Frequency of the radio in Mhz. Must match your
# module! Can be a value like 915.0, 433.0, etc.

# Define pins connected to the chip.
CS = digitalio.DigitalInOut(board.CE1)
RESET = digitalio.DigitalInOut(board.D25)

# Initialize SPI bus.
spi = busio.SPI(board.SCK, MOSI=board.MOSI, MISO=board.MISO)
# Initialize RFM radio
rfm69 = adafruit_rfm69.RFM69(spi, CS, RESET, RADIO_FREQ_MHZ)

# Optionally set an encryption key (16 byte AES key). MUST match both
# on the transmitter and receiver (or be set to None to disable/the default).
rfm69.encryption_key = (
    b"\x01\x02\x03\x04\x05\x06\x07\x08\x01\x02\x03\x04\x05\x06\x07\x08"
)

# set node addresses
rfm69.node = 1
rfm69.destination = 2
# initialize counter
counter = 0
# send a broadcast message from my_node with ID = counter
rfm69.send(
    bytes("Startup message {} from node {}".format(counter, rfm69.node), "UTF-8")
)

# Wait to receive packets.
print("Waiting for packets...")
now = time.monotonic()
```



```

while True:
    # Look for a new packet: only accept if addresses to my_node
    packet = rfm69.receive(with_header=True)
    # If no packet was received during the timeout then None is returned.
    if packet is not None:
        # Received a packet!
        # Print out the raw bytes of the packet:
        print("Received (raw header):", [hex(x) for x in packet[0:4]])
        print("Received (raw payload): {0}".format(packet[4:]))
        print("Received RSSI: {0}".format(rfm69.last_rssi))
    if time.monotonic() - now > transmit_interval:
        now = time.monotonic()
        counter = counter + 1
        # send a message to destination_node from my_node
        rfm69.send(
            bytes(
                "message number {} from node {}".format(counter, rfm69.node),
                "UTF-8"
            ),
            keep_listening=True,
        )

```

This script is to be run on the board designated as Node 2. It will report the packets received from Node 1 and send a reply to Node 1 after every 10th packet received.

```

# Example to send a packet periodically between addressed nodes
# Author: Jerry Needell
#
import time
import board
import busio
import digitalio
import adafruit_rfm69

# Define radio parameters.
RADIO_FREQ_MHZ = 915.0 # Frequency of the radio in Mhz. Must match your
# module! Can be a value like 915.0, 433.0, etc.

# Define pins connected to the chip.
CS = digitalio.DigitalInOut(board.CE1)
RESET = digitalio.DigitalInOut(board.D25)

# Initialize SPI bus.
spi = busio.SPI(board.SCK, MOSI=board.MOSI, MISO=board.MISO)

# Initialize RFM radio
rfm69 = adafruit_rfm69.RFM69(spi, CS, RESET, RADIO_FREQ_MHZ)

# Optionally set an encryption key (16 byte AES key). MUST match both
# on the transmitter and receiver (or be set to None to disable/the default).
rfm69.encryption_key = (
    b"\x01\x02\x03\x04\x05\x06\x07\x08\x01\x02\x03\x04\x05\x06\x07\x08"
)

# set node addresses
rfm69.node = 2
rfm69.destination = 1
# initialize counter
counter = 0
# send a broadcast message from my_node with ID = counter
rfm69.send(bytes("startup message from node {}".format(rfm69.node), "UTF-8"))

# Wait to receive packets.
print("Waiting for packets...")
# initialize flag and timer
time_now = time.monotonic()

```

```

while True:
    # Look for a new packet: only accept if addresses to my_node
    packet = rfm69.receive(with_header=True)
    # If no packet was received during the timeout then None is returned.
    if packet is not None:
        # Received a packet!
        # Print out the raw bytes of the packet:
        print("Received (raw header):", [hex(x) for x in packet[0:4]])
        print("Received (raw payload): {0}".format(packet[4:]))
        print("Received RSSI: {0}".format(rfm69.last_rssi))
        # send reading after any packet received
        counter = counter + 1
        # after 10 messages send a response to destination_node from my_node with
ID = counter&amp;0xff
        if counter % 10 == 0:
            time.sleep(0.5) # brief delay before responding
            rfm69.identifier = counter &amp; 0xFF
            rfm69.send(
                bytes(
                    "message number {} from node {} ".format(counter, rfm69.node),
                    "UTF-8",
                ),
                keep_listening=True,
            )

```

Reliable Datagram

During basic transmissions or the above address examples, there is no way to confirm if a packet was actually received by the destination node.

The "Reliable Datagram" mode attempts to provide that reassurance.

When invoked, this mode requires that every addressed packet (non-Broadcast) be acknowledged by sending a specially formatted ACK packet in response as described for the RadioHead Library <https://www.airspayce.com/mikem/arduino/RadioHead/classRHReliableDatagram.html> (<https://adafru.it/LAc>)

An ack consists of a message with:

- TO set to the from address of the original message
- FROM set to this node address
- ID set to the ID of the original message
- FLAGS with the RH_FLAGS_ACK bit set
- 1 octet of payload containing ASCII '!' (since some drivers cannot handle 0 length payloads)

Instead of the standard `send()` function use the `send_with_ack()` function. this configures the sending program to send the packet then wait for the responding ACK packet.

At the receiving node, the extra parameter `with_ack=True` must be passed to the `receive()` function so it generates the ACK packet in response.

This example sets up a "Reliable Datagram" exchange between Nodes 1 and 2. Node 1 sends a packet to Node 2 every 10 seconds and waits for an ACK. This script is executed by Node 1

```
# Example to send a packet periodically between addressed nodes with ACK
# Author: Jerry Needell
#
import time
import board
import busio
import digitalio
import adafruit_rfm69

# set the time interval (seconds) for sending packets
transmit_interval = 10

# Define radio parameters.
RADIO_FREQ_MHZ = 915.0 # Frequency of the radio in Mhz. Must match your
# module! Can be a value like 915.0, 433.0, etc.

# Define pins connected to the chip.
# set GPIO pins as necessary -- this example is for Raspberry Pi
CS = digitalio.DigitalInOut(board.CE1)
RESET = digitalio.DigitalInOut(board.D25)

# Initialize SPI bus.
spi = busio.SPI(board.SCK, MOSI=board.MOSI, MISO=board.MISO)
# Initialize RFM radio
rfm69 = adafruit_rfm69.RFM69(spi, CS, RESET, RADIO_FREQ_MHZ)

# Optionally set an encryption key (16 byte AES key). MUST match both
# on the transmitter and receiver (or be set to None to disable/the default).
rfm69.encryption_key = (
    b"\x01\x02\x03\x04\x05\x06\x07\x08\x01\x02\x03\x04\x05\x06\x07\x08"
)

# set delay before sending ACK
rfm69.ack_delay = 0.1
# set node addresses
rfm69.node = 1
rfm69.destination = 2
# initialize counter
counter = 0
ack_failed_counter = 0
# send startup message from my_node
rfm69.send_with_ack(bytes("startup message from node {}".format(rfm69.node),
"UTF-8"))

# Wait to receive packets.
print("Waiting for packets...")
# initialize flag and timer
time_now = time.monotonic()
while True:
    # Look for a new packet: only accept if addresses to my_node
    packet = rfm69.receive(with_ack=True, with_header=True)
    # If no packet was received during the timeout then None is returned.
    if packet is not None:
        # Received a packet!
        # Print out the raw bytes of the packet:
        print("Received (raw header):", [hex(x) for x in packet[0:4]])
        print("Received (raw payload): {}".format(packet[4:]))
```

```

    print("RSSI: {0}".format(rfm69.last_rssi))
    # send reading after any packet received
    if time.monotonic() - time_now > transmit_interval:
        # reset timer
        time_now = time.monotonic()
        counter += 1
        # send a message to destination_node from my_node
        if not rfm69.send_with_ack(
            bytes("message from node node {} {}".format(rfm69.node, counter),
"UTF-8")
        ):
            ack_failed_counter += 1
            print(" No Ack: ", counter, ack_failed_counter)

```

And this one is executed by Node 2. It acknowledges each packet and sends a response packet after a 2 second delay. Node 1 will acknowledge the response packet.

```

# Example to receive addressed packed with ACK and send a response
# Author: Jerry Needell
#
import time
import board
import busio
import digitalio
import adafruit_rfm69

# Define radio parameters.
RADIO_FREQ_MHZ = 915.0 # Frequency of the radio in Mhz. Must match your
# module! Can be a value like 915.0, 433.0, etc.

# Define pins connected to the chip.
# set GPIO pins as necessary - this example is for Raspberry Pi
CS = digitalio.DigitalInOut(board.CE1)
RESET = digitalio.DigitalInOut(board.D25)

# Initialize SPI bus.
spi = busio.SPI(board.SCK, MOSI=board.MOSI, MISO=board.MISO)
# Initialize RFM radio
rfm69 = adafruit_rfm69.RFM69(spi, CS, RESET, RADIO_FREQ_MHZ)

# Optionally set an encryption key (16 byte AES key). MUST match both
# on the transmitter and receiver (or be set to None to disable/the default).
rfm69.encryption_key = (
    b"\x01\x02\x03\x04\x05\x06\x07\x08\x01\x02\x03\x04\x05\x06\x07\x08"
)

# set delay before transmitting ACK (seconds)
rfm69.ack_delay = 0.1
# set node addresses
rfm69.node = 2
rfm69.destination = 1
# initialize counter
counter = 0
ack_failed_counter = 0

# Wait to receive packets.
print("Waiting for packets...")
while True:
    # Look for a new packet: only accept if addresses to my_node
    packet = rfm69.receive(with_ack=True, with_header=True)
    # If no packet was received during the timeout then None is returned.
    if packet is not None:
        # Received a packet!
        # Print out the raw bytes of the packet:

```

```
print("Received (raw header):", [hex(x) for x in packet[0:4]])
print("Received (raw payload): {}".format(packet[4:]))
print("RSSI: {}".format(rfm69.last_rssi))
# send response 2 sec after any packet received
time.sleep(2)
counter += 1
# send a message to destination_node from my_node
if not rfm69.send_with_ack(
    bytes("response from node {} {}".format(rfm69.node, counter), "UTF-8")
):
    ack_failed_counter += 1
    print(" No Ack: ", counter, ack_failed_counter)
```

Python Docs for RFM69

[Python Docs for RFM69 \(https://adafru.it/C5v\)](https://adafru.it/C5v)

CircuitPython for RFM9x LoRa

It's easy to use the RFM9x LoRa radio with CircuitPython and the [Adafruit CircuitPython RFM9x \(https://adafru.it/BjD\)](https://adafru.it/BjD) module. This module allows you to easily write Python code that sends and receives packets of data with the radio. Be careful to note this library is for the RFM95/96/97/98 LoRa radio only and **will not** work with the simpler RFM69 packet radio.

Design Considerations

One thing to be aware of before you use the RFM9x series of radios with CircuitPython are some of the limitations and design considerations for its module. Keep these in mind as you think about projects using the RFM9x and CircuitPython:

- You can only send and receive packets up to 252 bytes in length at a time. The size of the radio's internal buffer dictates this limit so if you want to send longer messages you'll need to break them into a series of smaller send calls in your application code.
- Receiving packets is a 'best effort' in pure Python code. Unlike the Arduino versions of the RFM9x library there is no interrupt support which means when a packet is received it must be immediately processed by the Python code or it could be lost. For your application it will work best to only receive small, single packet messages at a time. Don't try to receive kilobytes of data or else you'll lose packets. This module is really intended for simple single packet messages like 'ON', 'OFF', etc.
- Sending and receiving packets will 'block' your Python code until the packet is fully processed. This means you can't do a lot of other things while sending and waiting for packets to be received. Design your application so the radio usage

is the primary scenario and very little other tasks need to happen in the background.

- The module is written to be compatible with the RadioHead RFM95 Arduino library. This means by default the module will setup the radio with the same modulation and configuration for transmitting and receiving at the maximum distance with LoRa support. In addition the CircuitPython module uses the same packet preamble (8 bytes) and header (4 bytes) as RadioHead. If you want to use different modulations or settings you'll need to configure the radio yourself after carefully consulting the datasheet.
- The CircuitPython module supports advanced RadioHead features like the node addressing and "Reliable Datagram". "Reliable DataGram" mode in CircuitPython has some additional parameters to control timing that are not available with the RadioHead library. It may be difficult to get reliable transmission to work between the RadioHead library and CircuitPython.
- Encryption and sync words are also not supported by the LoRa radio module. You must perform these operations yourself in your application code if they're desired.

Wiring With Breakout

First wire up a RFM9x breakout to your board as shown on the previous pages for Arduino. Note that the GO/interrupt line is not used by the CircuitPython module and can remain unconnected. Here's an example of wiring a Feather M0 to the radio with a SPI connection:

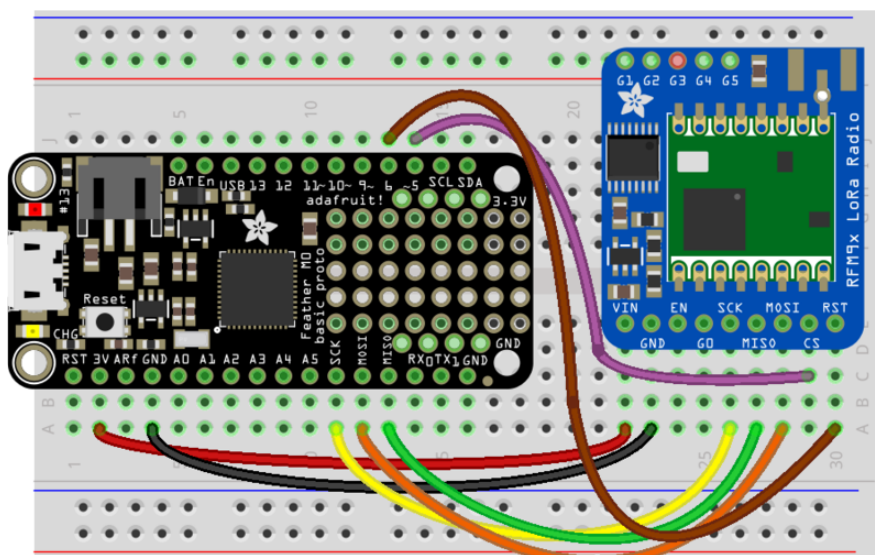

fritzing

- **Board 3V to radio VIN**

- Board GND to radio GND
- Board SCK to radio SCK
- Board MOSI to radio MOSI
- Board MISO to radio MISO
- Board D5 to radio CS (or any other digital I/O pin)
- Board D6 to radio RST (or any other digital I/O pin)

The Feather M0 LoRa does NOT come with UF2 bootloader or CircuitPython pre-installed, you can install CircuitPython as described below or update to the UF2 bootloader before installing CircuitPython

[Upgrading to the UF2 Bootlader \(https://adafru.it/ODG\)](https://adafru.it/ODG)

Usage with All-In-One Feather M0

Alternatively you can use the default bootloader on the Feather M0 RFM9x board but be sure you load the [adafruit-circuitpython-feather_m0_rfm9x-*.bin \(https://adafru.it/tBa\)](https://adafru.it/tBa) version of CircuitPython on your board! **This is very important as the RFM9x build has special pins added to the board module which are used to access the radio's control lines!**

[For details on how to load a binary circuitpython build, check out our Non-UF2-Install guide \(https://adafru.it/Bed\)](https://adafru.it/Bed)

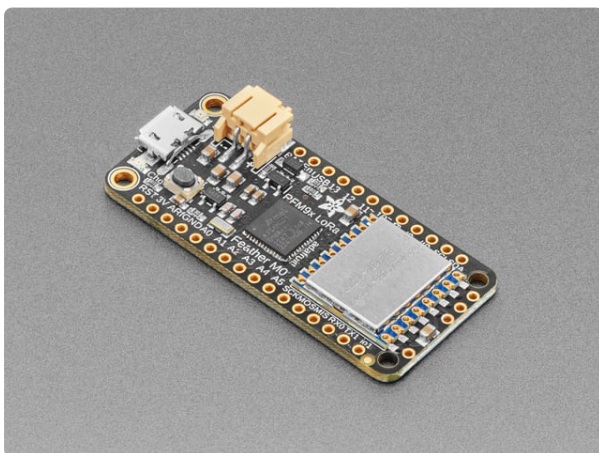

[Adafruit Feather M0 with RFM95 LoRa Radio - 900MHz](https://www.adafruit.com/product/3178)

This is the Adafruit Feather M0 RFM95 LoRa Radio (900MHz). We call these RadioFruits, our take on an microcontroller with a...

<https://www.adafruit.com/product/3178>

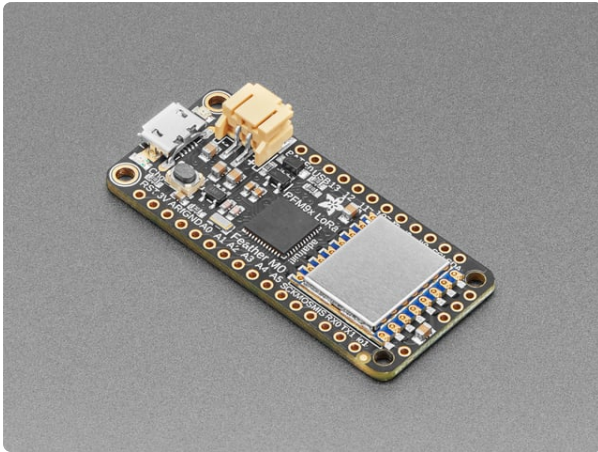

Adafruit Feather M0 RFM96 LoRa Radio - 433MHz

This is the Adafruit Feather M0 RFM96 LoRa Radio (433 MHz). We call these RadioFruits, our take on an microcontroller with a "

<https://www.adafruit.com/product/3179>

Module Install

If you have the Feather M0 RFM9x and have installed CircuitPython 6.0 or later, it is not necessary to install the library modules. They are "frozen into" the Circuitpython build. Skip to the "Usage" section below.

If you are using an older version of CircuitPython you will need to install the modules as described.

Next you'll need to install the [Adafruit CircuitPython RFM9x \(https://adafru.it/BjD\)](https://adafru.it/BjD) module on your CircuitPython board. Before you do that make sure you are running the [latest version of Adafruit CircuitPython \(https://adafru.it/Amd\)](https://adafru.it/Amd) for your board too (again be sure to the load the Feather M0 RFM9x version if you're using that board and want to use its built-in radio module).

Next you'll need to install the necessary libraries to use the hardware--carefully follow the steps to find and install these libraries from [Adafruit's CircuitPython library bundle \(https://adafru.it/zdx\)](https://adafru.it/zdx). Our introduction guide has [a great page on how to install the library bundle \(https://adafru.it/ABU\)](https://adafru.it/ABU) for both express and non-express boards.

Remember for non-express boards like the Feather M0 RFM96 and RFM95, you'll need to manually install the necessary libraries from the bundle:

- `adafruit_rfm9x.mpy`
- `adafruit_bus_device`

You can also download the `adafruit_rfm9x.mpy` from [its releases page on Github \(https://adafru.it/BI1\)](https://adafru.it/BI1).

Before continuing make sure your board's lib folder or root filesystem has the `adafruit_rfm9x.mpy`, and `adafruit_bus_device` files and folders copied over.

Usage

To demonstrate the usage of the radio we'll initialize it and send and receive data from the board's Python REPL.

[Connect to the board's serial REPL \(https://adafru.it/Awz\)](https://adafru.it/Awz) so you are at the CircuitPython >>> prompt.

Run the following code to import the necessary modules and initialize the SPI connection with the radio:

```
import board
import busio
import digitalio
spi = busio.SPI(board.SCK, MOSI=board.MOSI, MISO=board.MISO)
```

Now define a few of the pins connected to the RFM9x, specifically the CS and RST pins:

```
cs = digitalio.DigitalInOut(board.D5)
reset = digitalio.DigitalInOut(board.D6)
```

However if you're using the Feather M0 RFM95 board with a built-in RFM9x radio (and you've loaded the special version of CircuitPython just for this board as mentioned above), you instead want to use these pins for the CS and RST lines:

```
cs = digitalio.DigitalInOut(board.RFM9X_CS)
reset = digitalio.DigitalInOut(board.RFM9X_RST)
```

You're ready to import the RFM9x module and create an instance of the RFM9x class inside it. Before you create the radio module instance you'll need to check if you're using a 433mhz or 915mhz radio module as the initializer requires the frequency to be specified--confirm which frequency your module uses and run **one** of the following lines.

For a 915mhz radio use:

```
import adafruit_rfm9x
rfm9x = adafruit_rfm9x.RFM9x(spi, cs, reset, 915.0)
```

Or for a 433mhz radio use:

```
import adafruit_rfm9x
rfm9x = adafruit_rfm9x.RFM9x(spi, cs, reset, 433.0)
```

Notice the initializer takes the following required parameters:

- **spi** - The SPI bus connected to the board.
- **cs** - The DigitalInOut instance connected to the CS line of the radio.
- **reset** - The DigitalInOut instance connected to the RST or reset line of the radio.
- **frequency** - The frequency in megahertz of the radio module. Remember this frequency depends on which type of radio you're using and the frequency you desire to use!

In addition there are some optional parameters you might specify:

- **baudrate** - The baud rate to use for the SPI connection to the radio. By default this is 10mhz which is as fast as the radio can handle, but in some cases it might be too fast if you're wiring up a breakout to a breadboard (breadboards can be notorious for not working well with high speed signals). If you run into odd errors like being unable to find the RFM9x radio try lowering the baudrate by specifying a **baudrate=1000000** keyword (which sets the speed to a lower 1mhz value).

Once the RFM9x class is created and initialized you're ready to start sending and receiving data.

Remember by default the module will be configured to interface with the "RadioHead" RFM9x setup so you can also send and receive packets with an Arduino running the RFM95 TX/RX examples!

To send a message simply call the **send** function and provide a string or byte string of data:

```
rfm9x.send('Hello world!')
```

```
Received nothing! Listening again...
Received (raw bytes): bytearray(b'Hello World!')
Received (ASCII): Hello World!
Received nothing! Listening again...
```

Remember you can only send a message up to 252 bytes in length at a time!

Attempting to send a message longer than 252 bytes will fail with an exception error.

If you need to send a longer message it will have to be broken up into multiple send calls and reconstructed on the receiving side.

If you have another RFM9x on the same frequency waiting to receive messages (like another CircuitPython module running receive code below) you should see it receive the message.

You can even have an Arduino running the RadioHead library's RFM95 client example see the message that was sent:



To receive a message simply call the `receive` function. This function will wait for half a second for any packet to be received. If a packet is found it will be returned as a byte string (remember packets are at most 252 bytes long), or if no packet was found a result of `None` is returned.

```
rfm9x.receive()
```

You can increase the amount of time the module waits for a packet to be received by specifying the time in seconds as a parameter to the receive call:

```
rfm9x.receive(timeout=5.0) # Wait 5 seconds instead of 0.5 seconds.
```

Notice this waits longer at the REPL for a packet to be received before returning. If you have another RFM9x setup try having it send a message while the other is waiting to receive it. You should see a byte string returned. You can also have an Arduino running the RadioHead library's RFM95 client example send messages that are received by your code:

```
Received (raw bytes): bytearray(b'Hello World!')
Received (ASCII): Hello World!
Received nothing! Listening again...
Received nothing! Listening again...
Received nothing! Listening again...
Received nothing! Listening again...
Received nothing! Listening again...
Received nothing! Listening again...
Received (raw bytes): bytearray(b'Hello World!')
Received (ASCII): Hello World!
Received nothing! Listening again...
Received nothing! Listening again...
Received nothing! Listening again...
Received nothing! Listening again...
```

One thing to note in Python byte strings aren't exactly like text strings and you might not be able to do all the text processing (like find, replace, etc.) as you expect.

However you can convert a byte string into text by assuming a specific text encoding like ASCII. For example to receive a packet and convert the contents to an ASCII text string you can run code like:

```
packet = rfm9x.receive() # Wait for a packet to be received (up to 0.5 seconds)
if packet is not None:
    packet_text = str(packet, 'ascii')
    print('Received: {}'.format(packet_text))
```

Notice this code first receives a packet, then checks if one was actually found (the packet is **not None** check--if no packet is received a value of **None** is returned), and then converts the packet data to a string assuming an ASCII text encoding.

Beyond RX & TX

Beyond basic sending and receiving there are a few properties of the RFM69 class you might want to interact with:

- **tx_power** - This is a power level (in dB) to use when transmitting with the radio. By default this is set to a moderate 13 dB value, however you can increase this depending on the type of radio you're using. For high power radios (the modules sold by Adafruit) they support a range of TX power from 5 to 23 dB. Try increasing this to the maximum 23 dB level (however check your local laws for permission to transmit with such power!) to get the most distance and range.
- **rss** - The received signal strength indicator is a property you can read to see the strength of the radio signal being received. This is updated when packets are received and returns a value in decibels (typically negative, so the smaller the number and closer to 0, the higher the strength / better the signal).

```
>>> rfm9x.tx_power = 23
>>> rfm9x.send('High power hello world!\r\n')
>>> █
```

```
got reply: High power hello world!
```

```
>>> rfm9x.receive(timeout_s=5.0)
bytearray(b'Hello World!')
>>> print('RSSI: {0} dB'.format(rfm9x.rssi))
RSSI: -73 dB
>>> █
```

That's all there is to the basic RFM9x radio usage! Remember the CircuitPython module is designed for sending and receiving small up to 252 byte control messages and not large or high bandwidth amounts of data.

Here's a complete example of sending a message and waiting to receive and print any received messages. Save this as `main.py` on your board and open the serial REPL to see it print data and any received messages. If you have two boards and radios setup to run this code at the same time they'll send each other a message on start up!

```
# SPDX-FileCopyrightText: 2021 ladyada for Adafruit Industries
# SPDX-License-Identifier: MIT

# Simple demo of sending and receiving data with the RFM95 LoRa radio.
# Author: Tony DiCola
import board
import busio
import digitalio

import adafruit_rfm9x

# Define radio parameters.
RADIO_FREQ_MHZ = 915.0 # Frequency of the radio in Mhz. Must match your
# module! Can be a value like 915.0, 433.0, etc.

# Define pins connected to the chip, use these if wiring up the breakout according
# to the guide:
CS = digitalio.DigitalInOut(board.D5)
RESET = digitalio.DigitalInOut(board.D6)
# Or uncomment and instead use these if using a Feather M0 RFM9x board and the
# appropriate
# CircuitPython build:
# CS = digitalio.DigitalInOut(board.RFM9X_CS)
# RESET = digitalio.DigitalInOut(board.RFM9X_RST)

# Define the onboard LED
LED = digitalio.DigitalInOut(board.D13)
LED.direction = digitalio.Direction.OUTPUT

# Initialize SPI bus.
spi = busio.SPI(board.SCK, MOSI=board.MOSI, MISO=board.MISO)

# Initialize RFM radio
rfm9x = adafruit_rfm9x.RFM9x(spi, CS, RESET, RADIO_FREQ_MHZ)

# Note that the radio is configured in LoRa mode so you can't control sync
# word, encryption, frequency deviation, or other settings!

# You can however adjust the transmit power (in dB). The default is 13 dB but
# high power radios like the RFM95 can go up to 23 dB:
rfm9x.tx_power = 23
```

```

# Send a packet. Note you can only send a packet up to 252 bytes in length.
# This is a limitation of the radio packet size, so if you need to send larger
# amounts of data you will need to break it into smaller send calls. Each send
# call will wait for the previous one to finish before continuing.
rfm9x.send(bytes("Hello world!\r\n", "utf-8"))
print("Sent Hello World message!")

# Wait to receive packets. Note that this library can't receive data at a fast
# rate, in fact it can only receive and process one 252 byte packet at a time.
# This means you should only use this for low bandwidth scenarios, like sending
# and receiving a single message at a time.
print("Waiting for packets...")

while True:
    packet = rfm9x.receive()
    # Optionally change the receive timeout from its default of 0.5 seconds:
    # packet = rfm9x.receive(timeout=5.0)
    # If no packet was received during the timeout then None is returned.
    if packet is None:
        # Packet has not been received
        LED.value = False
        print("Received nothing! Listening again...")
    else:
        # Received a packet!
        LED.value = True
        # Print out the raw bytes of the packet:
        print("Received (raw bytes): {0}".format(packet))
        # And decode to ASCII text and print it too. Note that you always
        # receive raw bytes and need to convert to a text format like ASCII
        # if you intend to do string processing on your data. Make sure the
        # sending side is sending ASCII data before you try to decode!
        packet_text = str(packet, "ascii")
        print("Received (ASCII): {0}".format(packet_text))
        # Also read the RSSI (signal strength) of the last received message and
        # print it.
        rssi = rfm9x.last_rssi
        print("Received signal strength: {0} dB".format(rssi))

```

Advanced CircuitPython RFM9x Library Usage

RadioHead Header

Every packet transmitted via the CircuitPython RFM9x Library contains a 4 byte header compatible with the Arduino RadioHead Library.

<https://www.airspayce.com/mikem/arduino/RadioHead/classRHGenericDriver.html> (<https://adafru.it/LAa>)

Each message sent and received by a RadioHead driver includes 4 headers:

- TO - the node address that the message is being sent to (broadcast RH_BROADCAST_ADDRESS (255) is permitted)
- FROM - the node address of the sending node

- ID - a message ID, distinct (over short time scales) for each message sent by a particular node
- FLAGS - a bitmask of flags. The most significant 4 bits are reserved for use by RadioHead. The least significant 4 bits are reserved for applications.

For basic usage, the TO and FROM addresses are set to "Broadcast" with a value of 255 (0xff) and the ID and FLAGS parameters are ignored. With these settings any packet received will be accepted.

Radiohead Packet Header (4 bytes)

Byte 0				
TO — destination node for this packet (255 = Broadcast to ALL)				
Byte 1				
FROM — origin node for this packet (255 = Broadcast message - origin unknown)				
Byte 2				
ID - Identifier — contains sequence counter for Reliable Datagram Mode - User defined for other modes				
Byte 3				
Bit 7	Bit 6	Bit 5	Bit 4	Bits 3-0
1 = ACK Packet 0 = Normal Packet	1 = RETRY 0 = First attempt	RESERVED	RESERVED	User definable

Node Addressing

In many applications, it will be desirable to limit packets received to those originating at specified nodes and to direct responses to particular nodes. This can be controlled by setting the "node" and "destination" attributes for the rfm9x instance created in your CircuitPython code. <https://circuitpython.readthedocs.io/projects/rfm9x/en/latest/api.html> (<https://adafru.it/LAd>)

This example demonstrates the usage of the RadioHead Header settings to specify the address of the transmitting and receiving nodes.

This script is to be run on the board designated as Node 1. It will transmit a packet to Node 2 every 10 seconds

```
# Example to send a packet periodically between addressed nodes
# Author: Jerry Needell
#
import time
import board
import busio
```



```

import digitalio
import adafruit_rfm9x

# set the time interval (seconds) for sending packets
transmit_interval = 10

# Define radio parameters.
RADIO_FREQ_MHZ = 915.0 # Frequency of the radio in Mhz. Must match your
# module! Can be a value like 915.0, 433.0, etc.

# Define pins connected to the chip.
CS = digitalio.DigitalInOut(board.RFM9X_CS)
RESET = digitalio.DigitalInOut(board.RFM9X_RST)

# Initialize SPI bus.
spi = busio.SPI(board.SCK, MOSI=board.MOSI, MISO=board.MISO)
# Initialize RFM radio
rfm9x = adafruit_rfm9x.RFM9x(spi, CS, RESET, RADIO_FREQ_MHZ)

# enable CRC checking
rfm9x.enable_crc = True
# set node addresses
rfm9x.node = 1
rfm9x.destination = 2
# initialize counter
counter = 0
# send a broadcast message from my_node with ID = counter
rfm9x.send(
    bytes("Startup message {} from node {}".format(counter, rfm9x.node), "UTF-8")
)

# Wait to receive packets.
print("Waiting for packets...")
now = time.monotonic()
while True:
    # Look for a new packet: only accept if addresses to my_node
    packet = rfm9x.receive(with_header=True)
    # If no packet was received during the timeout then None is returned.
    if packet is not None:
        # Received a packet!
        # Print out the raw bytes of the packet:
        print("Received (raw header):", [hex(x) for x in packet[0:4]])
        print("Received (raw payload): {}".format(packet[4:]))
        print("Received RSSI: {}".format(rfm9x.last_rssi))
    if time.monotonic() - now > transmit_interval:
        now = time.monotonic()
        counter = counter + 1
        # send a message to destination_node from my_node
        rfm9x.send(
            bytes(
                "message number {} from node {}".format(counter, rfm9x.node),
                "UTF-8"
            ),
            keep_listening=True,
        )

```

This other script is to be run on the board designated as Node 2. It will report the packets received from Node 1 and send a reply to Node 1 after every 10th packet received.

```

# Example to send a packet periodically between addressed nodes
# Author: Jerry Needell
#
import time

```

```

import board
import busio
import digitalio
import adafruit_rfm9x

# Define radio parameters.
RADIO_FREQ_MHZ = 915.0 # Frequency of the radio in Mhz. Must match your
# module! Can be a value like 915.0, 433.0, etc.

# Define pins connected to the chip.
CS = digitalio.DigitalInOut(board.RFM9X_CS)
RESET = digitalio.DigitalInOut(board.RFM9X_RST)

# Initialize SPI bus.
spi = busio.SPI(board.SCK, MOSI=board.MOSI, MISO=board.MISO)

# Initialize RFM radio
rfm9x = adafruit_rfm9x.RFM9x(spi, CS, RESET, RADIO_FREQ_MHZ)

# enable CRC checking
rfm9x.enable_crc = True
# set node addresses
rfm9x.node = 2
rfm9x.destination = 1
# initialize counter
counter = 0
# send a broadcast message from my_node with ID = counter
rfm9x.send(bytes("startup message from node {}".format(rfm9x.node), "UTF-8"))

# Wait to receive packets.
print("Waiting for packets...")
# initialize flag and timer
time_now = time.monotonic()
while True:
    # Look for a new packet: only accept if addresses to my_node
    packet = rfm9x.receive(with_header=True)
    # If no packet was received during the timeout then None is returned.
    if packet is not None:
        # Received a packet!
        # Print out the raw bytes of the packet:
        print("Received (raw header):", [hex(x) for x in packet[0:4]])
        print("Received (raw payload): {}".format(packet[4:]))
        print("Received RSSI: {}".format(rfm9x.last_rssi))
        # send reading after any packet received
        counter = counter + 1
        # after 10 messages send a response to destination_node from my_node with
ID = counter&0xff
        if counter % 10 == 0:
            time.sleep(0.5) # brief delay before responding
            rfm9x.identifier = counter & 0xFF
            rfm9x.send(
                bytes(
                    "message number {} from node {}".format(counter, rfm9x.node),
                    "UTF-8",
                ),
                keep_listening=True,
            )

```

Reliable Datagram

During basic transmissions or the above address examples, there is no way to confirm if a packet was actually received by the destination node.

The "Reliable Datagram" mode attempts to provide that reassurance.

When invoked, this mode requires that every addressed packet (non-Broadcast) be acknowledged by sending a specially formatted ACK packet in response as described for the RadioHead Library <https://www.airspayce.com/mikem/arduino/RadioHead/classRHReliableDatagram.html> (<https://adafru.it/LAc>)

An ack consists of a message with:

- TO set to the from address of the original message
- FROM set to this node address
- ID set to the ID of the original message
- FLAGS with the RH_FLAGS_ACK bit set
- 1 octet of payload containing ASCII '!' (since some drivers cannot handle 0 length payloads)

Instead of the standard `send()` function use the `send_with_ack()` function. this configures the sending program to send the packet then wait for the responding ACK packet.

At the receiving node, the extra parameter `with_ack=True` must be passed to the `receive()` function so it generates the ACK packet in response.

This example sets up a "Reliable Datagram" exchange between Nodes 1 and 2. Node 1 sends a packet to Node 2 every 10 seconds and waits for an ACK.

This script is executed by Node 1

```
# Example to send a packet periodically between addressed nodes with ACK
# Author: Jerry Needell
#
import time
import board
import busio
import digitalio
import adafruit_rfm9x

# set the time interval (seconds) for sending packets
transmit_interval = 10

# Define radio parameters.
RADIO_FREQ_MHZ = 915.0 # Frequency of the radio in Mhz. Must match your
# module! Can be a value like 915.0, 433.0, etc.

# Define pins connected to the chip.
# set GPIO pins as necessary -- this example is for Raspberry Pi
CS = digitalio.DigitalInOut(board.RFM9X_CS)
RESET = digitalio.DigitalInOut(board.RFM9X_RST)

# Initialize SPI bus.
```

```

spi = busio.SPI(board.SCK, MOSI=board.MOSI, MISO=board.MISO)
# Initialize RFM radio
rfm9x = adafruit_rfm9x.RFM9x(spi, CS, RESET, RADIO_FREQ_MHZ)

# enable CRC checking
rfm9x.enable_crc = True
# set delay before sending ACK
rfm9x.ack_delay = 0.1
# set node addresses
rfm9x.node = 1
rfm9x.destination = 2
# initialize counter
counter = 0
ack_failed_counter = 0
# send startup message from my_node
rfm9x.send_with_ack(bytes("startup message from node {}".format(rfm9x.node),
"UTF-8"))

# Wait to receive packets.
print("Waiting for packets...")
# initialize flag and timer
time_now = time.monotonic()
while True:
    # Look for a new packet: only accept if addresses to my_node
    packet = rfm9x.receive(with_ack=True, with_header=True)
    # If no packet was received during the timeout then None is returned.
    if packet is not None:
        # Received a packet!
        # Print out the raw bytes of the packet:
        print("Received (raw header):", [hex(x) for x in packet[0:4]])
        print("Received (raw payload): {}".format(packet[4:]))
        print("RSSI: {}".format(rfm9x.last_rssi))
        # send reading after any packet received
    if time.monotonic() - time_now > transmit_interval:
        # reset timer
        time_now = time.monotonic()
        counter += 1
        # send a message to destination_node from my_node
        if not rfm9x.send_with_ack(
            bytes("message from node node {} {}".format(rfm9x.node, counter),
"UTF-8")
        ):
            ack_failed_counter += 1
            print(" No Ack: ", counter, ack_failed_counter)

```

This one is executed by Node 2. It acknowledges each packet and sends a response packet after a 2 second delay. Node 1 will acknowledge the response packet.

```

# Example to receive addressed packed with ACK and send a response
# Author: Jerry Needell
#
import time
import board
import busio
import digitalio
import adafruit_rfm9x

# Define radio parameters.
RADIO_FREQ_MHZ = 915.0 # Frequency of the radio in Mhz. Must match your
# module! Can be a value like 915.0, 433.0, etc.

# Define pins connected to the chip.
# set GPIO pins as necessary - this example is for Raspberry Pi
CS = digitalio.DigitalInOut(board.RFM9X_CS)
RESET = digitalio.DigitalInOut(board.RFM9X_RST)

```

```

# Initialize SPI bus.
spi = busio.SPI(board.SCK, MOSI=board.MOSI, MISO=board.MISO)
# Initialize RFM radio
rfm9x = adafruit_rfm9x.RFM9x(spi, CS, RESET, RADIO_FREQ_MHZ)

# enable CRC checking
rfm9x.enable_crc = True
# set delay before transmitting ACK (seconds)
rfm9x.ack_delay = 0.1
# set node addresses
rfm9x.node = 2
rfm9x.destination = 1
# initialize counter
counter = 0
ack_failed_counter = 0

# Wait to receive packets.
print("Waiting for packets...")
while True:
    # Look for a new packet: only accept if addresses to my_node
    packet = rfm9x.receive(with_ack=True, with_header=True)
    # If no packet was received during the timeout then None is returned.
    if packet is not None:
        # Received a packet!
        # Print out the raw bytes of the packet:
        print("Received (raw header):", [hex(x) for x in packet[0:4]])
        print("Received (raw payload): {}".format(packet[4:]))
        print("RSSI: {}".format(rfm9x.last_rssi))
        # send response 2 sec after any packet received
        time.sleep(2)
        counter += 1
        # send a message to destination_node from my_node
        if not rfm9x.send_with_ack(
            bytes("response from node {} {}".format(rfm9x.node, counter), "UTF-8")
        ):
            ack_failed_counter += 1
            print(" No Ack: ", counter, ack_failed_counter)

```

CRC Checking

The above examples also enable CRC checking.

if a packet fails the CRC check, it will be ignored. A warning is presented to the REPL if it is open, but the packet is not returned. This helps avoid having to deal with corrupted packets. When used with the "Reliable DataGram" mode, the packet will not be ACK'ed so it will be resent.

```

# enable CRC checking
rfm9x.enable_crc = True

```

If a CRC error occurs, it is reported to the REPL as a warning - no Exception is generated.

```

UserWarning: CRC error, packet ignored
warn("CRC error, packet ignored")

```

Python Docs for RFM9x LoRa

[Python Docs for RFM9x LoRa \(https://adafru.it/C5w\)](https://adafru.it/C5w)

Advanced CircuitPython Library RFM9x/ RFM69 - Tweaking Parameters

One of the factors that limits the reliability of packet transmission and receipt using CircuitPython is the current lack of support for "interrupts". This means that the library can only "poll" for available packets and there are significant time gaps when the code is switching between transmit and receive. Packets can be missed during these transitions. Using the Reliable Datagram mode should help, but even with that there are cases when the timing just does not work well. There are several parameters that can be adjusted to help minimize the likelihood of a missed packet.

These parameters are noted [here for the RFM9x \(https://adafru.it/LAd\)](https://adafru.it/LAd) and [here for the RFM69 \(https://adafru.it/LAb\)](https://adafru.it/LAb). The RFM9x is used as an example below, but the parameters are the same for the RFM69.

If you are having trouble receiving the ACK packets from the the recipient, it may be helpful to enable a delay between receipt of the packet and transmission of the ACK packet.

This is done via the `ack_delay` attribute. The default setting is `None` so the ACK packet is sent as quickly as possible. This may be too fast for some systems, especially when using a Raspberry Pi where there can be delays associated with the operating system.

A delay of 0.1 seconds was used in the Reliable Datagram examples:

```
# Initialize SPI bus.
spi = busio.SPI(board.SCK, MOSI=board.MOSI, MISO=board.MISO)
# Initialize RFM radio
rfm9x = adafruit_rfm9x.RFM9x(spi, CS, RESET, RADIO_FREQ_MHZ)

# enable CRC checking
rfm9x.enable_crc = True
# set delay before transmitting ACK (seconds)
rfm9x.ack_delay = 0.1
# set node addresses
rfm9x.node = 2
rfm9x.destination = 1
```

Other parameters that may be useful to adjust are:

- `rfm9x.ack_wait` (defaults to 0.5ms)
 - This sets the delay before retrying transmission of a packet after no ACK has been received.
- `rfm9x.receive_timeout` (defaults to 0.5ms)
 - Set the amount of time the `receive()` function will listen for incoming packets before returning if none received. This can also be passed as a function argument.
- `rfm9x.ack_retries` (defaults to 5 retries)
 - Set the number of retries to attempt if no ACK message is received.

Another simple adjustment is to pay attention to when packets are transmitted after receipt. Depending on the application, it may be helpful to add a delay between the receipt of a packet and the transmission of a response.

```
# send response 2 sec after any packet received
time.sleep(2)
```

RFM9X Test

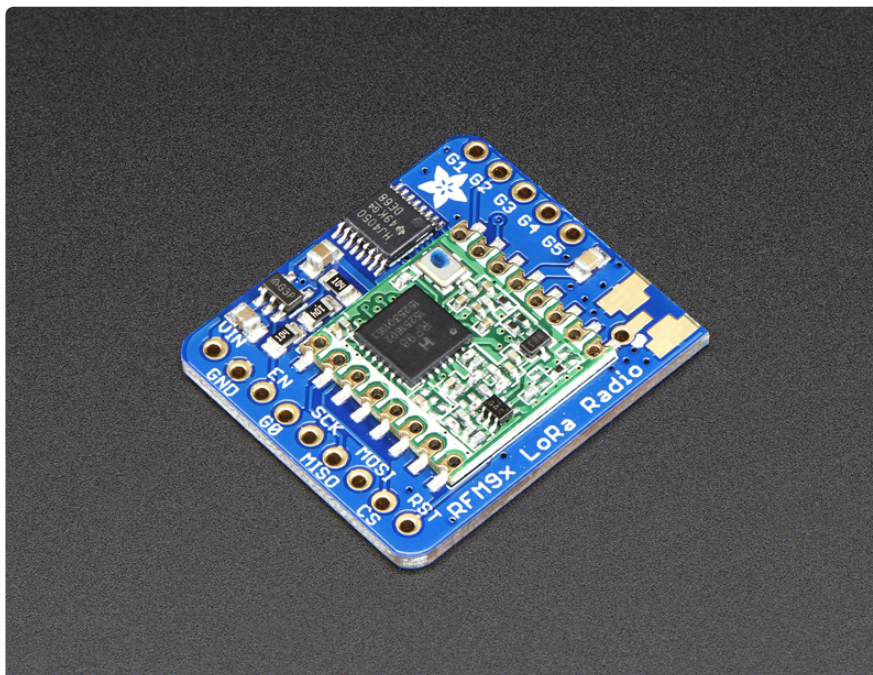

Note that the sub-GHz radio is not designed for streaming audio or video! It's best used for small packets of data. The data rate is adjustable but it's common to stick to

around 19.2 Kbps (thats bits per second). Lower data rates will be more successful in their transmissions

You will, of course, need at least two paired radios to do any testing! The radios must be matched in frequency (e.g. 900 MHz & 900 MHz are ok, 900 MHz & 433 MHz are not). They also must use the same encoding schemes, you cannot have a 900 MHz RFM69 packet radio talk to a 900 MHz RFM96 LoRa radio.

Arduino Library

These radios have really excellent code already written, so rather than coming up with a new standard we suggest using existing libraries such as [AirSpayce's Radiohead library \(https://adafru.it/mCA\)](#) which also supports a vast number of other radios

This is a really great Arduino Library, so please support them in thanks for their efforts!

RadioHead RFM9x Library example

To begin talking to the radio, you will need to download the [RadioHead library \(https://adafru.it/mCA\)](#). You can do that by visiting the github repo and manually downloading or, easier, just click this button to download the zip corresponding to version 1.59

Note that while all the code in the examples below are based on this version you can [visit the RadioHead documentation page to get the most recent version which may have bug-fixes or more functionality \(https://adafru.it/mCA\)](#)

[Download RadioHead v1.59](#)

<https://adafru.it/mHC>

Uncompress the zip and find the folder named **RadioHead** and check that the **RadioHead** folder contains **RH_RF95.cpp** and **RH_RF95.h** (as well as a few dozen other files for radios that are supported)

Place the **RadioHead** library folder your **arduinodesketchfolder/libraries/** folder. You may need to create the **libraries** subfolder if its your first library. Restart the IDE.

We also have a great tutorial on Arduino library installation at: <http://learn.adafruit.com/adafruit-all-about-arduino-libraries-install-use> (<https://adafru.it/aYM>)

Basic RX & TX example

Lets get a basic demo going, where one Arduino transmits and the other receives.
We'll start by setting up the transmitter

Transmitter example code

This code will send a small packet of data once a second to node address #1

Load this code into your Transmitter Arduino!

```
// LoRa 9x_TX
// -*- mode: C++ -*-
// Example sketch showing how to create a simple messaging client (transmitter)
// with the RH_RF95 class. RH_RF95 class does not provide for addressing or
// reliability, so you should only use RH_RF95 if you do not need the higher
// level messaging abilities.
// It is designed to work with the other example LoRa9x_RX

#include <SPI.h>;
#include <RH_RF95.h>;

#define RFM95_CS 10
#define RFM95_RST 9
#define RFM95_INT 2

// Change to 434.0 or other frequency, must match RX's freq!
#define RF95_FREQ 915.0

// Singleton instance of the radio driver
RH_RF95 rf95(RFM95_CS, RFM95_INT);

void setup()
{
  pinMode(RFM95_RST, OUTPUT);
  digitalWrite(RFM95_RST, HIGH);

  while (!Serial);
  Serial.begin(9600);
  delay(100);

  Serial.println("Arduino LoRa TX Test!");

  // manual reset
  digitalWrite(RFM95_RST, LOW);
  delay(10);
  digitalWrite(RFM95_RST, HIGH);
  delay(10);

  while (!rf95.init()) {
    Serial.println("LoRa radio init failed");
    while (1);
  }
  Serial.println("LoRa radio init OK!");

  // Defaults after init are 434.0MHz, modulation GFSK_Rb250Fd250, +13dbm
  if (!rf95.setFrequency(RF95_FREQ)) {
    Serial.println("setFrequency failed");
    while (1);
  }
}
```

```

}
Serial.print("Set Freq to: "); Serial.println(RF95_FREQ);

// Defaults after init are 434.0MHz, 13dBm, Bw = 125 kHz, Cr = 4/5, Sf = 128chips/
symbol, CRC on

// The default transmitter power is 13dBm, using PA_BOOST.
// If you are using RFM95/96/97/98 modules which uses the PA_BOOST transmitter
pin, then
// you can set transmitter powers from 5 to 23 dBm:
rf95.setTxPower(23, false);
}

int16_t packetnum = 0; // packet counter, we increment per xmission

void loop()
{
  Serial.println("Sending to rf95_server");
  // Send a message to rf95_server

  char radiopacket[20] = "Hello World #      ";
  itoa(packetnum++, radiopacket+13, 10);
  Serial.print("Sending "); Serial.println(radiopacket);
  radiopacket[19] = 0;

  Serial.println("Sending..."); delay(10);
  rf95.send((uint8_t *)radiopacket, 20);

  Serial.println("Waiting for packet to complete..."); delay(10);
  rf95.waitPacketSent();
  // Now wait for a reply
  uint8_t buf[RH_RF95_MAX_MESSAGE_LEN];
  uint8_t len = sizeof(buf);

  Serial.println("Waiting for reply..."); delay(10);
  if (rf95.waitAvailableTimeout(1000))
  {
    // Should be a reply message for us now
    if (rf95.recv(buf, &len))
    {
      Serial.print("Got reply: ");
      Serial.println((char*)buf);
      Serial.print("RSSI: ");
      Serial.println(rf95.lastRssi(), DEC);
    }
    else
    {
      Serial.println("Receive failed");
    }
  }
  else
  {
    Serial.println("No reply, is there a listener around?");
  }
  delay(1000);
}

```

Once uploaded you should see the following on the serial console

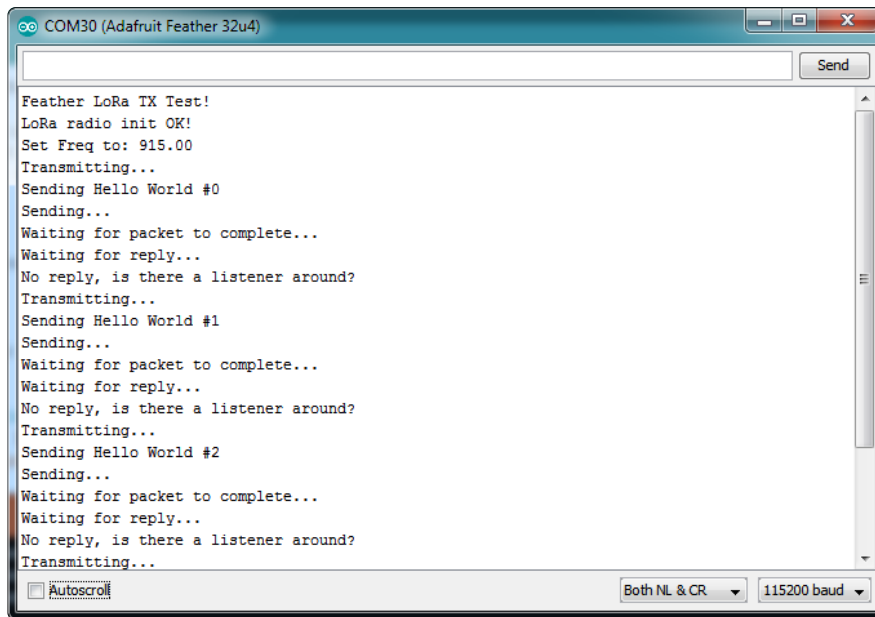

Now open up another instance of the Arduino IDE - this is so you can see the serial console output from the TX Arduino while you set up the RX Arduino.

Receiver example code

This code will receive and acknowledge a small packet of data.

Load this code into your **Receiver** Arduino!

```
// Arduino9x_RX
// -*- mode: C++ -*-
// Example sketch showing how to create a simple messaging client (receiver)
// with the RH_RF95 class. RH_RF95 class does not provide for addressing or
// reliability, so you should only use RH_RF95 if you do not need the higher
// level messaging abilities.
// It is designed to work with the other example Arduino9x_TX

#include <SPI.h>;
#include <RH_RF95.h>;

#define RFM95_CS 10
#define RFM95_RST 9
#define RFM95_INT 2

// Change to 434.0 or other frequency, must match RX's freq!
#define RF95_FREQ 915.0

// Singleton instance of the radio driver
RH_RF95 rf95(RFM95_CS, RFM95_INT);

// Blinky on receipt
#define LED 13

void setup()
{
  pinMode(LED, OUTPUT);
  pinMode(RFM95_RST, OUTPUT);
  digitalWrite(RFM95_RST, HIGH);
}
```

```

while (!Serial);
Serial.begin(9600);
delay(100);

Serial.println("Arduino LoRa RX Test!");

// manual reset
digitalWrite(RFM95_RST, LOW);
delay(10);
digitalWrite(RFM95_RST, HIGH);
delay(10);

while (!rf95.init()) {
  Serial.println("LoRa radio init failed");
  while (1);
}
Serial.println("LoRa radio init OK!");

// Defaults after init are 434.0MHz, modulation GFSK_Rb250Fd250, +13dBm
if (!rf95.setFrequency(RF95_FREQ)) {
  Serial.println("setFrequency failed");
  while (1);
}
Serial.print("Set Freq to: "); Serial.println(RF95_FREQ);

// Defaults after init are 434.0MHz, 13dBm, Bw = 125 kHz, Cr = 4/5, Sf = 128chips/
symbol, CRC on

// The default transmitter power is 13dBm, using PA_BOOST.
// If you are using RFM95/96/97/98 modules which uses the PA_BOOST transmitter
pin, then
// you can set transmitter powers from 5 to 23 dBm:
rf95.setTxPower(23, false);
}

void loop()
{
  if (rf95.available())
  {
    // Should be a message for us now
    uint8_t buf[RH_RF95_MAX_MESSAGE_LEN];
    uint8_t len = sizeof(buf);

    if (rf95.recv(buf, &len))
    {
      digitalWrite(LED, HIGH);
      RH_RF95::printBuffer("Received: ", buf, len);
      Serial.print("Got: ");
      Serial.println((char*)buf);
      Serial.print("RSSI: ");
      Serial.println(rf95.lastRssi(), DEC);

      // Send a reply
      uint8_t data[] = "And hello back to you";
      rf95.send(data, sizeof(data));
      rf95.waitPacketSent();
      Serial.println("Sent a reply");
      digitalWrite(LED, LOW);
    }
    else
    {
      Serial.println("Receive failed");
    }
  }
}
}

```

Now open up the Serial console on the receiver, while also checking in on the transmitter's serial console. You should see the receiver is...well, receiving packets

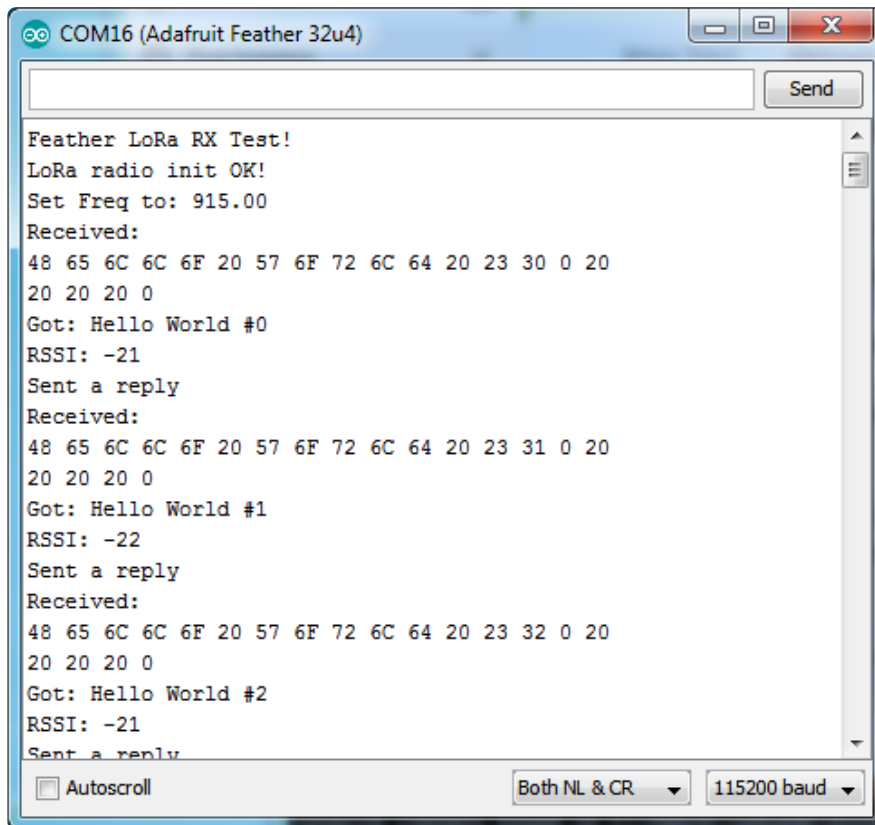

You can see that the library example prints out the hex-bytes received `48 65 6C 6C 6F 20 57 6F 72 6C 64 20 23 30 0 20 20 20 20 0`, as well as the ASCII 'string' `Hello World`. Then it will send a reply.

And, on the transmitter side, it is now printing that it got a reply after each transmission `And hello back to you` because it got a reply from the receiver

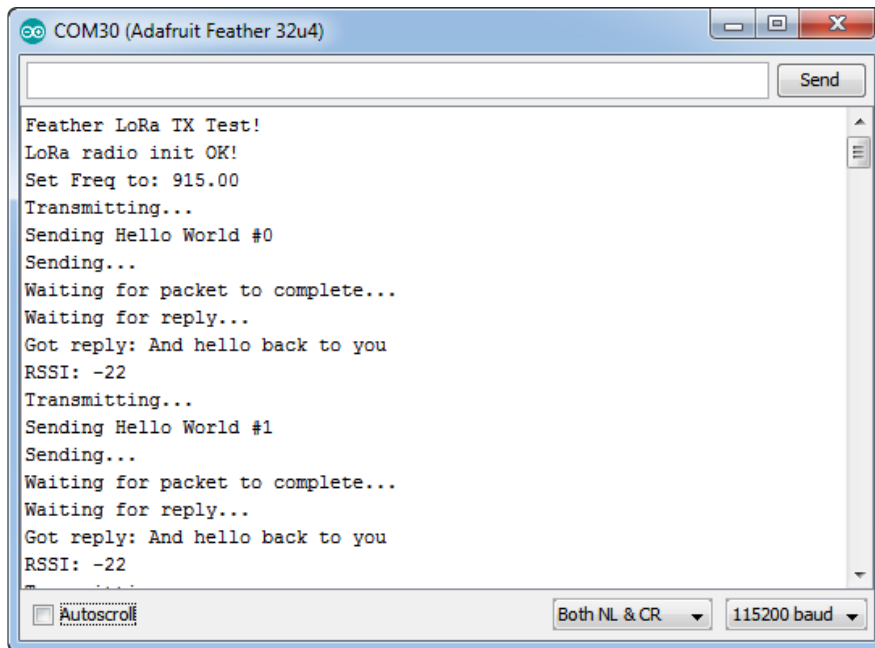

That's pretty much the basics of it! Lets take a look at the examples so you know how to adapt to your own radio setup

Radio Pinout

This is the pinout setup - you can change around the reset and CS pins to any pin. the IRQ pin should be an interrupt pin. On an UNO this is pin #2 or pin #3. Each chipset has different interrupt pins!

```
#define RFM95_CS 10
#define RFM95_RST 9
#define RFM95_INT 2
```

Frequency

You can dial in the frequency you want the radio to communicate on, such as 915.0, 434.0 or 868.0 or any number really. Different countries/ITU Zones have different ISM bands so make sure you're using those or if you are licensed, those frequencies you may use

```
// Change to 434.0 or other frequency, must match RX's freq!
#define RF95_FREQ 915.0
```

You can then instantiate the radio object with our custom pin numbers.

```
// Singleton instance of the radio driver
RH_RF95 rf95(RFM95_CS, RFM95_INT);
```

Setup

We begin by setting up the serial console and hard-resetting the Radio

```
void setup()
{
  pinMode(LED, OUTPUT);
  pinMode(RFM95_RST, OUTPUT);
  digitalWrite(RFM95_RST, HIGH);

  while (!Serial); // wait until serial console is open, remove if not tethered to
computer
  Serial.begin(9600);
  delay(100);
  Serial.println("Arduino LoRa RX Test!");

  // manual reset
  digitalWrite(RFM95_RST, LOW);
  delay(10);
  digitalWrite(RFM95_RST, HIGH);
  delay(10);
}
```

Remove the **while (!Serial);** line if you are not tethering to a computer, as it will cause the Arduino to halt until a USB connection is made!

Initializing Radio

The library gets initialized with a call to **init()**. Once initialized, you can set the frequency. You can also configure the output power level, the number ranges from 5 to 23. Start with the highest power level (23) and then scale down as necessary

```
while (!rf95.init()) {
  Serial.println("LoRa radio init failed");
  while (1);
}
Serial.println("LoRa radio init OK!");

// Defaults after init are 434.0MHz, modulation GFSK_Rb250Fd250, +13dBm
if (!rf95.setFrequency(RF95_FREQ)) {
  Serial.println("setFrequency failed");
  while (1);
}
Serial.print("Set Freq to: "); Serial.println(RF95_FREQ);

// Defaults after init are 434.0MHz, 13dBm, Bw = 125 kHz, Cr = 4/5, Sf = 128chips/
symbol, CRC on

// The default transmitter power is 13dBm, using PA_BOOST.
// If you are using RFM95/96/97/98 modules which uses the PA_BOOST transmitter
pin, then
// you can set transmitter powers from 5 to 23 dBm:
rf95.setTxPower(23, false);
```

Transmission Code

If you are using the transmitter, this code will wait 1 second, then transmit a packet with "Hello World #" and an incrementing packet number

```
void loop()
{
  delay(1000); // Wait 1 second between transmits, could also 'sleep' here!
  Serial.println("Transmitting..."); // Send a message to rf95_server

  char radiopacket[20] = "Hello World #      ";
  itoa(packetnum++, radiopacket+13, 10);
  Serial.print("Sending "); Serial.println(radiopacket);
  radiopacket[19] = 0;

  Serial.println("Sending..."); delay(10);
  rf95.send((uint8_t *)radiopacket, 20);

  Serial.println("Waiting for packet to complete..."); delay(10);
  rf95.waitPacketSent();
}
```

Its pretty simple, the delay does the waiting, you can replace that with low power sleep code. Then it generates the packet and appends a number that increases every tx. Then it simply calls **send** to transmit the data, and passes in the array of data and the length of the data.

Note that this does not any addressing or subnetworking - if you want to make sure the packet goes to a particular radio, you may have to add an identifier/address byte on your own!

Then you call **waitPacketSent()** to wait until the radio is done transmitting. You will not get an automatic acknowledgement, from the other radio unless it knows to send back a packet. Think of it like the 'UDP' of radio - the data is sent, but its not certain it was received! Also, there will not be any automatic retries.

Receiver Code

The Receiver has the same exact setup code, but the loop is different

```
void loop()
{
  if (rf95.available())
  {
    // Should be a message for us now
    uint8_t buf[RH_RF95_MAX_MESSAGE_LEN];
    uint8_t len = sizeof(buf);

    if (rf95.recv(buf, &len))
    {
      digitalWrite(LED, HIGH);
      RH_RF95::printBuffer("Received: ", buf, len);
    }
  }
}
```



```
Serial.print("Got: ");  
Serial.println((char*)buf);  
Serial.print("RSSI: ");  
Serial.println(rf95.lastRssi(), DEC);
```

Instead of transmitting, it is constantly checking if there's any data packets that have been received. **available()** will return true if a packet with proper error-correction was received. If so, the receiver prints it out in hex and also as a 'character string'

It also prints out the RSSI which is the receiver signal strength indicator. This number will range from about -15 to about -100. The larger the number (-15 being the highest you'll likely see) the stronger the signal.

Once done it will automatically reply, which is a way for the radios to know that there was an acknowledgement

```
// Send a reply  
uint8_t data[] = "And hello back to you";  
rf95.send(data, sizeof(data));  
rf95.waitPacketSent();  
Serial.println("Sent a reply");
```

It simply sends back a string and waits till the reply is completely sent

Downloads

Datasheets & Files

- [SX127x Datasheet](http://adafru.it/31791276777879) (<http://adafru.it/31791276777879>)- The RFM9X LoRa radio chip itself
- [SX1231 Datasheet](http://adafru.it/30761231) (<http://adafru.it/30761231>) - The RFM69 radio chip itself
- [RFM69HCW datasheet](http://adafru.it/30766911) (<http://adafru.it/30766911>)- [contains the SX1231 datasheet plus details about the module](https://adafru.it/mFX) (<https://adafru.it/mFX>)
- [RFM9X](https://adafru.it/19CS) (<https://adafru.it/19CS>) - The radio module, which contains the SX1272 chipset
- [RFM69 FCC Test Report](http://adafru.it/307030703076699152) (<http://adafru.it/307030703076699152>)
- [RFM9x FCC Test Report](https://adafru.it/19sD) (<https://adafru.it/19sD>)
- [EagleCAD PCB files on GitHub](https://adafru.it/oem) (<https://adafru.it/oem>)
- [Fritzing objects in the Adafruit Fritzing library](https://adafru.it/c7M) (<https://adafru.it/c7M>)

Schematic

RFM69 and RFM9X have the same pinout so the same schematic is used

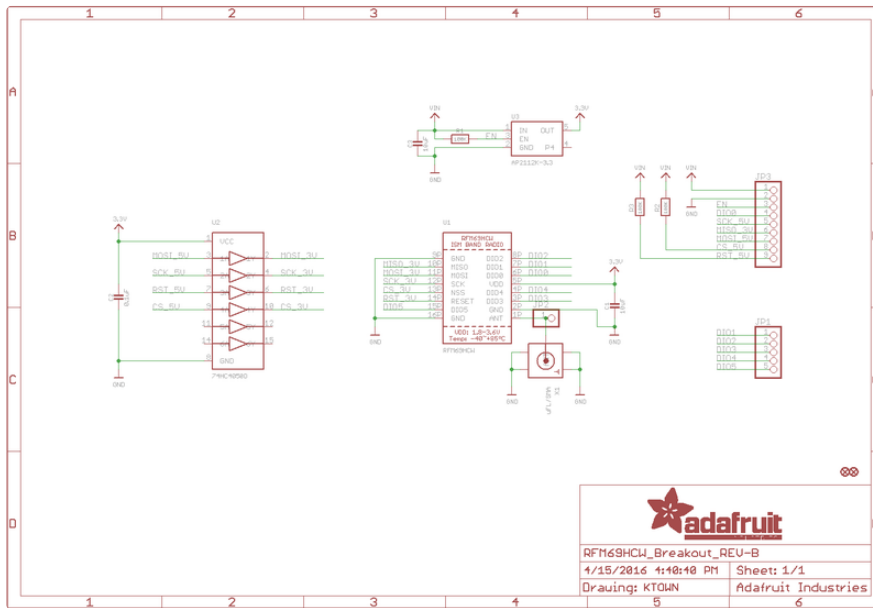

Fabrication Print

RFM69 and RFM9X have the same layout so the same board is used

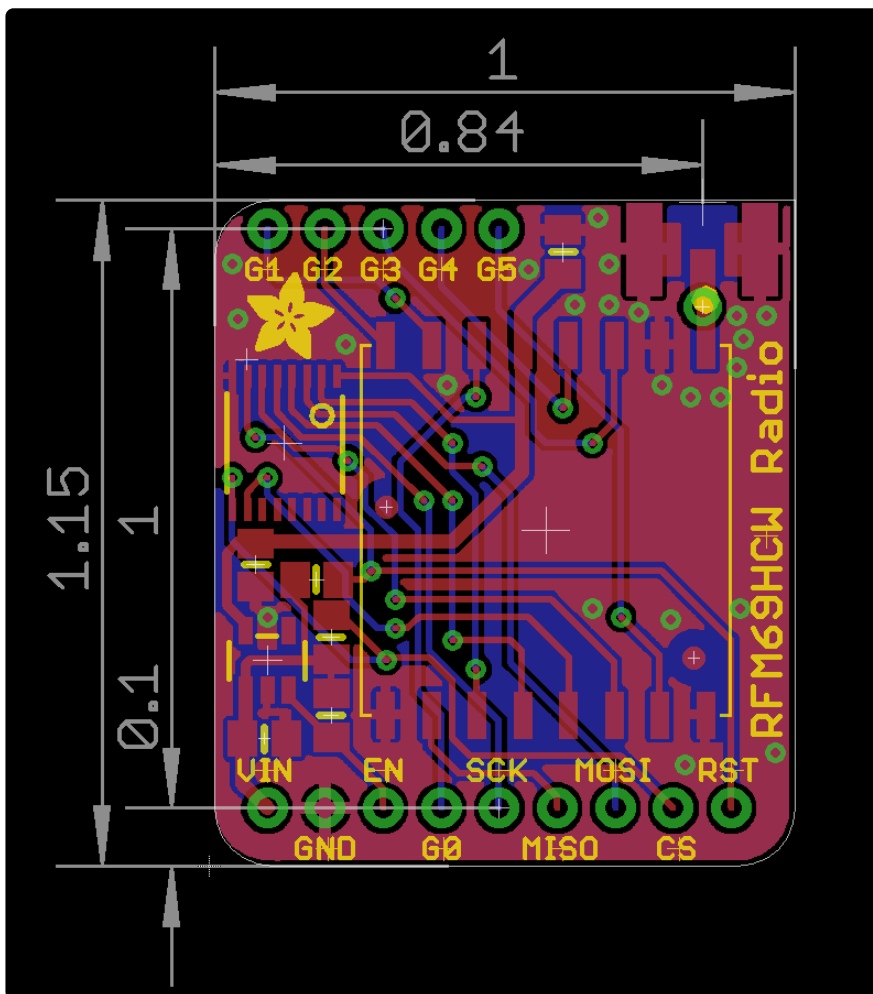

Radio Module F.A.Q.

Which gives better range, LoRa or RFM69?

All other things being equal (antenna, power output, location) you will get better range with LoRa than with RFM69 modules. We've found 50% to 100% range improvement is common.

What ranges can I expect for RFM69 radios?

The RFM69 radios have a range of approx. 500 meters **line of sight** with tuned uni-directional antennas. Depending on obstructions, frequency, antenna and power output, you will get lower ranges - especially if you are not line of sight.

What ranges can I expect for RFM9X LoRa radios?

The RFM9x radios have a range of up to 2 km **line of sight** with tuned uni-directional antennas. Depending on obstructions, frequency, antenna and power output, you will get lower ranges - especially if you are not line of sight.

I don't seem to be getting the range advertised! Is my module broken?

Your module is probably not broken. Radio range is dependant on a lot of things and all must be attended to make sure you get the best performance!

1. Tuned antenna for your frequency - getting a well-tuned antenna is incredibly important. Your antenna must be tuned for the exact frequency you are using
2. Matching frequency - make sure all modules are on the same exact frequency
3. Matching settings - all radios must have the same settings so they can communicate
4. Directional vs non-directional antennas - for the best range, directional antennas like Yagi will direct your energy in one path instead of all around
5. Good power supply - a nice steady power supply will keep your transmissions clean and strong
6. Max power settings on the radios - they can be set for higher/lower power! Don't forget to set them to max.
7. Line of sight - No obstructions, walls, trees, towers, buildings, mountains, etc can be in the way of your radio path. Likewise, outdoors is way better than indoors because its very hard to bounce radio paths around a building

8. Radio transmission speed - trying to transmit more data faster will be hard. Go for small packets, with lots of retransmissions. Lowering the baud rate on the radio (see the libraries for how to do this) will give you better reliability

How do I pick/design the right antenna?

Various antennas will cost different amounts and give you different directional gain. In general, spending a lot on a large fixed antenna can give you better power transfer if the antenna is well tuned. For most simple uses, a wire works pretty well

The [ARRL antenna book](https://adafru.it/sdN) is recommended if you want to learn how to do the modeling and analysis (<https://adafru.it/sdN>)

But nothing beats actual tests in your environment!

What frequency is my module?

Look for a little colored paint dot on top of the module.

- **GREEN, BLUE** or **NO DOT** = **900 MHz**
- **RED** = **433 MHz**

Every now and then the paint dot shows up without a color or with the ink dot burnt. This is just a manufacturing variance and there is nothing wrong with the board. You should get the frequency you ordered though. So if you plan on mixing these up, you may want to add a new mark of your own.

My radio has a burnt blob on it, is it damaged?

Nope! The radios have an ink dot on them, which sometimes gets toasty when we put the board through the oven, or rework it, so it may have a burnt appearance. The chip is fine!

What is the MAC address used for?

Each LoRa device from Adafruit should come with a small label that contains a MAC address in the form **98:76:B6:xx:yy:zz**. This might be a sticker attached to the device itself or included separately. This MAC address is needed if using the LoRa device with [LoRaWAN \(https://adafru.it/18D0\)](https://adafru.it/18D0). For example, [The Things Network \(https://adafru.it/BsB\)](https://adafru.it/BsB) uses LoRaWAN. For non-LoRaWAN usage, the MAC address is not needed.